



ENVIROSPEC 2009

Cleaning Products from the future
with today's environment in mind-

Serving the
INDUSTRIAL CLEANING INDUSTRY
Since 1972

1-800-346-4876

Revised 06.02.09

...a sunrise on Jekyll Island, GA

TABLE OF CONTENTS

Ball Valves	20	Nozzle Holders, Dual, Twist, all	42
Battery Box	56	Nozzle, Adj. Cone, Lo Press	45
Battery Selector	56	Nozzle, Telescoping Wand	36
Battery, Boxes & Terminals	56	Nozzle, Thruster	44
Burners & Burner Parts	49-52	Nozzles, High Pressure	39-40
Brushes	47	Nozzles, Hi-Lo, Push-Pull	41
Burst Disc	32	Nozzles, Low Pressure Soap	41
Ceramic Balls	27	Nozzles, Rotating Turbo	43-44
Chemical Induction System	15-16	Nozzles, Sewer	42
Chemical Metering Valve	35	Oil Caps, Pump	57
Chemical Tubing	45	O-ring Pick	27
Chemicals	67-80	O-ring, Quick Connect	28
Concrete Cleaners	17-19	Pressure Washers, Jetters	1-16
Cyclone Chlorine System	14	Pulleys, Bushings	58
Drum Wrench	34	Pump Kits	62
Easy Start Valve	32	Pump Oil	57
Engines & Filters	53-54	Pump Rails	59
Exhaust Hood Cleaners	13, 32	Pump Tools	58
Filters, Chemical	29-30	Pumps, High Pressure	59-51
Filters, Water	26	Pumps, ShurFlo	46
Fittings, High Pressure	31	Quick Connects	27-28
Float Valves	25	Recovery, Waste Water	46
Flow Meter, Water	25	Reels, Hose	37
Foam Cannon	34	Roof Cleaner	48
Frames, Wheels, Base Plates	55	Roof/Ice Walkers	48
Fuel Line	56	Safety Pressure Relief	32
Garden Hose Connectors	26	Sand Blast Equipment	48
Garden Hose Quick Connects	34	Sewer Jetting Valves	58
Gas Cap, Replacement	56	Siphon Pump	34
Gauges, Pressure	10	Sludge Pump	34
Gear Reducers	58	Solenoid, Gas Engine	56
Gauge Ports, Pump	58	Spray Flex Lance	35
Gutter Sweep	35	Sprayers, Lo Press, Pump-ups	47
Hose Ends, Re-usable	38	Swivels, Hose Reel	25
Hose Whip	23	Swivels, In-line	23
Hose, Fire Hydrant	26	Tanks, Gas & Fuel	13
Hose, Pressure & Sewer	38	Telescoping Long Wand	36
Injectors, Chemical	29-30	Test Equipment, Pressure	10
Jack, Trailer	53	Thermal Pump Protector	32
Key Switch	56	Thread Locker	57
Lances	35-36	Throttle Cable	53
Lid Remover	34	Throttle Control	56
Mixers, Drill, Chemical	25	Trigger Guns	21-22
Mud Cat	48	Trigger Guns for ShurFlo/Flojet	45
Nozzle Boot	42	Unloader By-pass Hose	20
Nozzle Caddy	42	Unloader Mounting Block	20
Nozzle Chart	39	Unloaders	23-24
Nozzle Clean Out Tool	41	Washer, Garden Hose	26



"Millie"



"Gabby"



"Oreo"



"Bella"



"Spirit"

Here are just a few of the many reasons we work so hard.

Through your chemical purchases we are able to save thousands of these little lives each year.

Visit our 'state of the art' Animal Shelter at <http://www.suziesfriends.org>

"An animal's eyes have the power to speak a great language."



"Sunday"

SALES POLICIES

It is the
Consumers Responsibility
to provide the
CUSTOMER SERVICE REP
with the
CORRECT PART NUMBER

Remember, if you don't know what you want, the best we can do is guess right along with you. We will do everything humanly possible to help you when you have a question - but you can not hold us responsible if you ask for our help and we make a mistake. With our intense and constant training programs we feel our Customer Service Reps know as much or more about our industry than do those of our competition. However, keep in mind that YOU are the PROFESSIONAL and you should know your equipment better than anyone. If you do need assistance and would like to talk directly to our Technical Service Advisor or the Manufacturer of a particular item before ordering, please ask your Customer Service Rep for their extension or phone number and try and remember - when I was a Mobile Washer there was no such thing as an "800" number to call to get a question answered. I had to figure it out for myself and today I am glad I did. Learn your equipment. It will make you a stronger professional. John Allison

Did you know...
one female cat
and her offspring
can produce
420,000 CATS
in 7 years?
please
Spay/Neuter

DISCLAIMER

Some of the pictures within this catalog are for illustration purposes only. Be sure and ask your sales representative if the item in question is represented by the picture herein. EnviroSpec reserves the right to limit quantities of any item(s) in this catalog. Prices are subject to change without notice. It is the purchasers responsibility to order by part number and to ask the sales representative to read back the order along with the current pricing and availability. This catalog is for the sole intent to sell to industry professionals only and possession of this catalog or any marketing material from EnviroSpec does not necessarily mean that we will be able to sell to you.

RESTOCKING CHARGE

Any item that is ordered incorrectly and is returned to EnviroSpec within 30 days of purchase and in a "not used" or "not installed" condition and where the credit is to remain on the customers account for future purchases will be credited at full purchase price. If the item in question is to be credited back to the customers credit card it will be done so less 15%. If payment was made by check we will hold a credit in the customers account. Any credit held in a customers account must be used in it's entirety when the customer places his/her next order. Remember, Items must be returned pre-paid to EnviroSpec and must be in unused condition and showing no signs of mounting and/or installation.

RETURNS

Items ordered and not returned within **30 days** from the original order date or items ordered that are not in our catalog **ARE NOT** returnable. If you are ordering an item that is not in our catalog and would like to talk to the manufacturer first we will gladly give you their phone number. Just ask!

TERMS

EnviroSpec accepts Master Card, VISA, Discover, and AMEX. Pressure Washers must be paid for by Certified Funds ONLY or Wire Transfer.

Price Match Guarantee - find any legitimately advertised item in our catalog elsewhere for less and not only will we meet their price but we will beat it by 5%. Vendor or Manufacturer 'close-outs', Mosmatic items & Honda engines do not qualify.

Shipping is not refundable.

WARRANTY

All items sold in this catalog are **NEW** and not refurbished or used components. EnviroSpec does not warranty any item in this catalog except those that are manufactured by EnviroSpec. All warranties are presented to the buyer by the original manufacturer and must be returned, pre-paid, to EnviroSpec for evaluation and adjustments. All returned items must be accompanied by an "RGA" (Returned Goods Authorization) which EnviroSpec will provide to you. EnviroSpec **WILL NOT** send out replacement item(s) on a "no-charge" basis while EnviroSpec or the manufacturer is evaluating a returned item. If you need an immediate replacement you will have to purchase said replacement. However, you must understand that all items are covered by a "repair" or "replace" warranty and you could wind up with two of the same items. *We like to call them "spares".*

EQUIPMENT PURCHASES

If you purchase a Pressure Washer or Hot Water Heater you do so under the same terms and conditions that a Pressure Washer Distributor would purchase said equipment. Simply put, we **DO NOT** provide any labor warranty but only a warranty on Parts and Components that go into the make-up of the final product. Also, you **MUST UNDERSTAND** that in shipping large equipment - nuts, bolts, components, etc. may work loose and adjustments may have to be made prior to using the equipment. If you indicate to us that you are familiar with the equipment so you will be able to take advantage of huge discounts and you find yourself needing a pressure washer distributor in your area to make adjustment or repairs for you - you will not be entitled to any labor reimbursement. Remember, you must be able to work on your equipment or you should buy from your local distributor.

RECEIVING YOUR PACKAGES

DO NOT SIGN FOR ANYTHING that looks like it has been damaged! Refuse it so we can handle the UPS/Shipping Claim. IF YOU DO SIGN FOR IT and there is a problem WE CAN NOT HELP YOU. At that point you will have to contact the shipping company for adjustments. If UPS leaves a package without your signature and there are damages call your local UPS and have them pick up the package. Do not throw away any packaging on damaged goods. Save for UPS Inspection.

CHEMICALS ARE NOT RETURNABLE

...FOR THE DISCERNING PROFESSIONAL WHO KNOWS, UNDERSTANDS & DEMANDS PERFORMANCE & QUALITY.



Shown with
2 each
880.000
BTU
HEATERS



It is a fact that approximately 85% of all Mobile Washers that go into business today will be out of business in less than 3 years. The majority will go out simply because they are not equipped to do the job. And when you don't 'look the part' you can't ask professional prices. This is why you see so many people washing houses for \$79.95, where a properly equipped contractor will get \$400.00 for the same job. Consumers know the value of equipment and they find it hard to justify higher prices when they can rent the same equipment that the contractor shows up with from the local rental store for \$29.95 per day.

Prospective clients know you are a serious and capable contractor when you show up with our equipment. More often than not the job is half sold simply because you look like a professional and you look like you have made the necessary investment in your company that will translate into being able to provide the services they need.



125 AMP RECHARGING
Enough to run both heaters
and plenty of outside DC lighting

Gas System Features:

- Two Allison Pumps with 5 year head warranty
- Std. 40 HP Kohler Engine with auto spark advance
- High Efficiency Donaldson Air Filter
- High volume Allison downstream Chemical Injection
- The largest recharging system in the industry with a 25 Amp back-up recharging system
- The industry's largest and most efficient heating system
- Our special spec SDC 12 Volt Burners will heat water hotter and more efficiently
- Allison Relays for trouble free 12 Volt Burner life
- Poly Chain 'never tighten' belts
- 24 Gal Gas Tank for long, uninterrupted run times.
- Quick Drain Oil System for Engine & Pumps
- Tachometer/Hour Meter
- No-mess Oil Filter change system
- 8000 PSI Safety Burst Disc
- 7500 PSI On/Off Valves
- Lifetime Frame Warranty
- Lifetime Belt Warranty

**NET
PRICING**

SYSTEM SPECIFICATIONS - OTHER CONFIGURATIONS AVAIL.

Cold Water	Hot Water Vertical 18 HP/490,000 BTU 40 HP/880,000 BTU	Engine	Using One Gun you can run from...	Using Two Guns... Four Guns...
SPG5530C w/Generator \$3,995.00	SPG5530H w/Generator \$6290.00	18 HP BRIGGS	5.6 GPM @ 3000 PSI	Single Gun System
SPG8022C w/Generator \$4,495.00	SPG8022H w/Generator \$6,790.00	18 HP BRIGGS	8.0 GPM @ 2200 PSI	Single Gun System
DP1138C \$6,995.00	DP1138H \$12,385.00	40 HP KOHLER	5.6 GPM @ 4500 PSI up to 11.2 GPM @ 3800 PSI	5.6 GPM @ 3800 PSI x 2
DP1626C \$6,995.00	DP1626H \$12,385.00	40 HP KOHLER	8.0 GPM @ 4000 PSI up to 16.0 GPM @ 2600 PSI	8 GPM @ 2600 PSI x 2 4 GPM @ 2600 PSI x 4
DP2020C \$6,995.00	DP2020H \$12,385.00	40 HP KOHLER	10.0 GPM @ 3500 PSI up to 20.0 GPM @ 2000 PSI	10 GPM @ 2000 PSI x 2 5 GPM @ 2000 PSI x 4
DP2517C \$6,995.00	DP2517H \$12,385.00	40 HP KOHLER	12.5 GPM @ 3000 PSI up to 25.0 GPM @ 1700 PSI	12 GPM @ 1700 PSI x 2 6 GPM @ 1700 PSI x 4

See Kubota Systems On Page 3 & 4

Sewer Jetting Valves Add \$400.00



DUAL PUMPER

'Power in the Hands of a Few'

There is **'RED HOT'** and then
there is a **'hotter hot...'**

WHITE HOT

UP TO 4 GUN SYSTEM



Up to 24 GPM - Up to 4,500 PSI



‘Revolutionary’, ‘Dynamic’, ‘Raw Power’, and ‘Pure Performance’

Yes - those are just a few of the key words that we can conjure up in our attempt to describe the allison iron horse pressure washers & sewer jetters

When you first see the Allison System your impression will be unmistakable. This is a genuine performance system designed to fulfill every expectation of the discerning professional who demands, understands and appreciates quality & performance.



Shown with 2
880,000 BTU
HEATERS

The initial concept of the Allison Iron Horse did not come about by accident. In the mid-70’s John Allison started a Mobile Wash/Sewer Jetting business. He quickly found that every machine he purchased had to be re-designed after he received it just to make it both practical and functional.

Yes, contractors require a much different design than what is coming off the assembly lines even today. Unless you have been out there trying to make a living using one, you can’t know and understand their requirements says Allison.

Owning one of the Allison Iron Horse systems has always been uniquely satisfying. Thanks to our broad & varied lineup of exciting and innovative system specifications, it has never been more so than now.

Allison Iron Horse systems are technological marvels, integrating a myriad of high-performance technologies to serve one master, the professional contractor.



24 Gallon
Long Run
Fuel Tank

UP TO 4 GUN SYSTEM

The acclaimed Allison built systems coordinates the best engines and pumps, the best drive systems, the best unloading devices, guns, coils & burners; all of which are housed within the confines of the industries most rugged frames. This unique combination of features makes for a fully integrated system that redefines the notion of cleaning and jetting dynamics.

CERTIFIED HAND CRAFTED

From the turning of the first bolt to running the last test - only one person touches your machine. And you can rest assured that each machine is built and tested using the toughest and most rigorous standards in the industry.

Yes...

anyone can build a pressure washer/ sewer jetter, *but only we can build an Iron Horse.*



System Features:

- Two Allison Iron Horse Pumps with 5 year head warranty
- Kubota or Kohler Industrial Power Plants
- High Capacity Recharge System
- High volume Allison downstream Chemical Injection
- Allison Downstream Chemical Induction System
- Poly Chain 'never tighten' belts
- 24 Gal Fuel Tank for long, uninterrupted run times.
- Quick Drain Oil System for Engine & Pumps
- Tachometer/Hour Meter
- 8000 PSI Safety Burst Disc
- 7500 PSI On/Off Valves
- High Capacity Water Filtration System
- Glycerin Filled Pressure Gauges
- YU2140 Unloader
- Unloader Mounting Blocks
- Lifetime Frame Warranty
- Lifetime Belt Warranty

NET PRICING

Sewer Jetting Valves Add \$400.00

DIESEL SPECIFICATIONS - OTHER CONFIGURATIONS AVAIL.

Cold Water	Hot Water Vertical 880,000 BTU	Engine	Using One Gun you can run from...	Using Two Guns... Four Guns...
35K1135C \$8,995.00	35K1135H \$14,385.00	35 HP KUBOTA	5.5 GPM @ 4500 PSI up to 11.0 GPM @ 3500 PSI	5.5 GPM @ 3500 PSI x 2
35K2020C \$8,995.00	35K2020H \$14,385.00	35 HP KUBOTA	10.0 GPM @ 3500 PSI up to 20.0 GPM @ 2000 PSI	10 GPM @ 2000 PSI x 2 5 GPM @ 2000 PSI x 4
35K2516C \$8,995.00	35K2516H \$14,385.00	35 HP KUBOTA	12.5 GPM @ 3000 PSI up to 25.0 GPM @ 1600 PSI	12.5 GPM @ 1600 PSI x 2 6 GPM @ 1600 PSI x 4
65K1150C \$11,995.00	65K1150H \$17,385.00	65 HP KUBOTA	5.5 GPM @ 5000 PSI up to 11.0 GPM @ 5000 PSI	5.5 GPM @ 5000 PSI x 2
65K1445C \$11,995.00	65K1445H \$17,385.00	65 HP KUBOTA	7.0 GPM @ 4500 PSI up to 14.0 GPM @ 4500 PSI	7.0 GPM @ 4500 PSI x 2
65K1640C \$11,995.00	65K1640H \$17,385.00	65 HP KUBOTA	8.0 GPM @ 4000 PSI up to 16.0 GPM @ 4000 PSI	8 GPM @ 4000 PSI x 2 4 GPM @ 4000 PSI x 4
65K2035C \$11,995.00	65K2035H \$17,385.00	65 HP KUBOTA	10.0 GPM @ 3500 PSI up to 20.0 GPM @ 3500 PSI	10 GPM @ 3500 PSI x 2 5 GPM @ 3500 PSI x 4
65K2530C \$11,995.00	65K2530H \$17,385.00	65 HP KUBOTA	12.5 GPM @ 3000 PSI up to 25.0 GPM @ 3000 PSI	12.5 GPM @ 3000 PSI x 2 6 GPM @ 3000 PSI x 4

...FOR THE DISCERNING PROFESSIONAL
WHO KNOWS, UNDERSTANDS AND DEMANDS
POWER & PERFORMANCE



Model Shown
N1030HWC
w/optional heater

Optional Chemical
Induction Pump
injects massive amounts
of chemical into the
Allison downstream
injection system.

**NET
PRICING**



NITRO

'Power in the Hands of a Few'

SYSTEM SPECIFICATIONS - MANY OTHER CONFIGURATIONS AVAILABLE

COLD WATER	HOT WATER VERTICAL	Engine	Using One Gun you can run from...	Using Two Guns you can run...
N5535C18 \$2,995.00	N5535H18 \$5,290.00 490,000 BTU	18 HP VANGUARD	5.5 GPM @ 3500	Single Gun System
N8040C30 \$4,995.00	N8040H30 \$7,690.00 880,000 BTU	30 HP KOHLER (Shown page 6)	4.0 GPM @ 4000 PSI or 8.0 GPM @ 4000 PSI	2 Guns @ 4.0 GPM & 4000 PSI each
N1030CWC \$4,995.00	N1030HWC \$7,690.00 880,000 BTU	28 HP WATER COOLED KOHLER (Shown this page)	5.0 GPM @ 3000 PSI or 10.0 GPM @ 3000 PSI	2 Guns @ 5.0 GPM & 3000 PSI each
N1032C30 \$4,995.00	N1032H30 \$7,690.00 880,000 BTU	30 HP KOHLER (Shown page 6)	5.0 GPM @ 3200 PSI or 10.0 GPM @ 3200 PSI	2 Guns @ 5.0 GPM & 3200 PSI each
N1226C30 \$4,995.00	N1226H30 \$7,690.00 880,000 BTU	30 HP KOHLER (Shown page 6)	6.0 GPM @ 2600 PSI up to 12.5 GPM @ 2600 PSI	2 Guns @ 6.0 GPM & 2600 PSI each

WATER COOLED ENGINES CAN BE INTERCHANGED WITH ANY GPM/PSI CONFIGURATION

NITRO SYSTEM

UP TO **30 HP**

UP TO **12 GPM**



LARGE
VOLUME
FUEL TANK



TWO GUN SYSTEM

Sewer Jetting Valve
Add \$200.00

TNT HONDA ENGINES

UP TO 30 HP
UP TO 12 GPM

TWO GUN SMALL FOOTPRINT SPACE SAVER

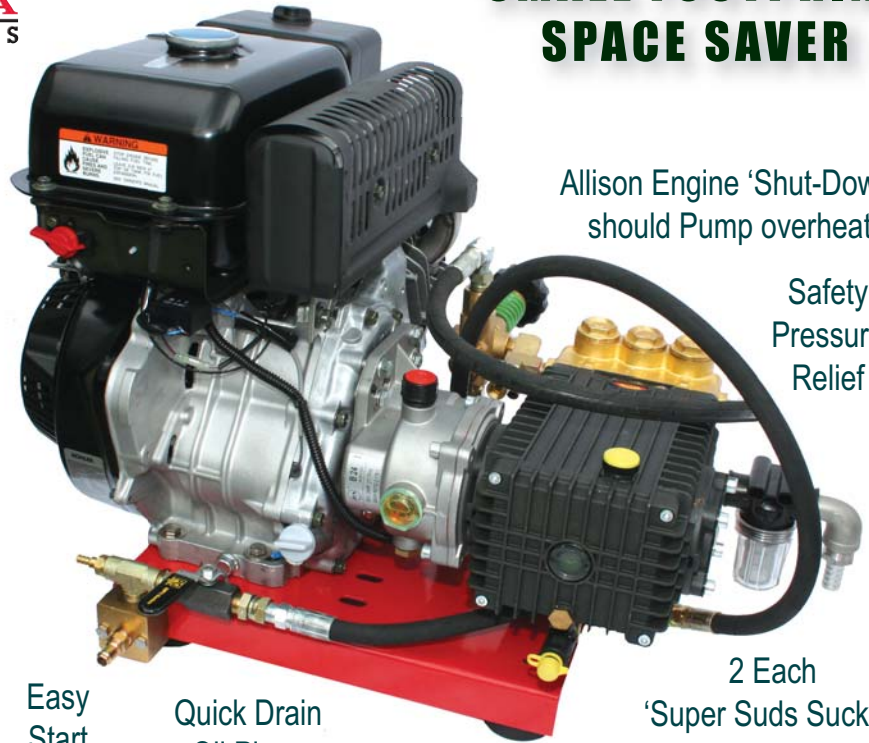

Allison Engine 'Shut-Down'
should Pump overheat

Safety
Pressure
Relief

Easy
Start
Valve

Quick Drain
Oil Plugs

Tachometer / Hour Meter

2 Each
'Super Suds Sucker'
Chem Injector



YU2140 Unloader
The Industry's Best
High Volume
Unloader

DUAL BEARING TRANSMISSION DRIVE

Sewer Jetting Valve
Add \$200.00

JUST ADD WATER!

...that and a floor to bolt it down to is all you will need to be up and running with this compact beast!

This pressure washer is for contractors who need more volume, less pressure and quick production times.

SYSTEM SPECIFICATIONS

P/N & NET PRICE	Engine	Using One Gun you can run from...	Using Two Guns you can run...
TNT1032 \$4,495.00	30 HP KOHLER	5.0 GPM @ 3500 PSI up to 10.0 GPM @ 3200 PSI	2 Guns each @ 5.0 GPM & 3200 PSI each
TNT1225 \$4,495.00	30 HP KOHLER	6.0 GPM @ 3000 PSI up to 12.5 GPM @ 2500 PSI	2 Guns each @ 6.0 GPM & 2500 PSI each

MORE CONFIGURATIONS Available - CALL

System above is shown with top mount fuel tank which is no longer available. See optional fuel tank base to the left.

HIGH VOLUME HEATERS

DUAL-PASS COIL SYSTEM

PERFORMANCE beyond your wildest imagination!



SYSTEM SPECIFICATIONS		
P/N	CONFIGURATION & VOLUME	ELECTRICITY REQUIRED
9898 - \$2,995.00 880,000 BTU COIL	HORIZONTAL UP TO 12 GPM	12 VOLT
9899 - \$2,995.00 880,000 BTU COIL	HORIZONTAL UP TO 12 GPM	120 VOLT
9817 - \$2,295.00 490,000 BTU COIL	VERTICAL UP TO 6 GPM	12 VOLT
9815 - \$2,295.00 490,000 BTU COIL	VERTICAL UP TO 6 GPM	120 VOLT
9816 - \$2,695.00 880,000 BTU COIL	VERTICAL UP TO 12 GPM	12 VOLT
9814 - \$2,695.00 880,000 BTU COIL	VERTICAL UP TO 12 GPM	120 VOLT

1-800-346-4876

There is 'red hot' and then there is a 'hotter hot...'

WHITE HOT

...up to

880,000 BTU

RENEGADE 2009



18 HP and above are Hot Water Ready with 20 to 25 AMP Recharging Systems!

- Engines with 'low oil shut-down'
- Industrial Pumps
- Up to 4,500 PSI & 12.5 GPM
- Industrial Unloader
- Safety Pressure Relief Valve
- Cart is Aircraft Aluminum
- Injector, Gun, Hose & Lance sold separately
- Completely Assembled

Model	PSI/GPM	Engine/HP	Drive	NET Price	
9850	3500 - 4.0	Honda 13	4 Belts	\$ 1,395.00	Belt Drive Cart
9851	3000 - 4.5	Honda 13	4 Belts	\$ 1,395.00	Belt Drive Cart
9852	3500 - 5.5	18 Vanguard	4 Belts	\$ 1,795.00	Belt Drive Cart
9854	3500 - 5.5	18 Kohler	4 Belts	\$ 1,795.00	Belt Drive Cart
9888	3500 - 5.5	18 Vanguard	Gear	\$ 1,795.00	Gear Drive Cart
9889	3500 - 5.5	18 Kohler	Gear	\$ 1,795.00	Gear Drive Cart
9860	3500 - 5.5	18 Vanguard	Gear	\$ 1,695.00	Bolt to floor Base Plate Shown
9862	3500 - 5.5	18 Vanguard	Direct Drive	\$ 1,595.00	Bolt to floor Base Plate Shown
9863	3500 - 5.5	18 Kohler	Gear	\$ 1,695.00	Bolt to floor Base Plate Shown5
9865	3500 - 5.5	18 Kohler	Direct Drive	\$ 1,595.00	Bolt to floor Base Plate Shown
9866	3500 - 7.0	22 Kohler	Gear	\$ 2,695.00	Bolt to floor Base Plate Shown
9867	3400 - 8.0	25 Kohler	Gear	\$ 2,795.00	Bolt to floor Base Plate Shown
9868	3200 - 10.0	27 Kohler	Gear	\$ 2,895.00	Bolt to floor Base Plate Shown
9869	4000 - 8.0	30 Kohler	Gear	\$ 2,995.00	Bolt to floor Base Plate Shown
9870	2500 - 12.5	30 Kohler	Gear	\$ 2,995.00	Bolt to floor Base Plate Shown
9890	3500 - 5.5	18 Vanguard	Gear	\$ 1,590.00	Bare System - No Cart or Base Plate
9891	4000 - 5.0	18 Vanguard	Gear	\$ 1,690.00	Bare System - No Cart or Base Plate
9892	3500 - 5.5	18 Vanguard	Direct Drive	\$ 1,490.00	Bare System - No Cart or Base Plate
9893	3500 - 5.5	18 Kohler	Gear	\$ 1,590.00	Bare System - No Cart or Base Plate
9894	4000 - 5.0	18 Kohler	Gear	\$ 1,690.00	Bare System - No Cart or Base Plate
9895	3500 - 5.5	18 Kohler	Direct Drive	\$ 1,490.00	Bare System - No Cart or Base Plate



HOT WATER READY!
20 or 25 AMP Recharging!



KOHLER

- Bare Systems are ideal if you already have a base plate or just want to bolt the engine directly to the floor.

- Gear Systems are the preferred system in the industry. These are the finest gear/transmission drives on the market and feature 'dual', matched and balanced roller bearings. We have been building gear driven pressure washers for over 25 years with '0' gear failures to date.

Please Note: These systems are not the typical pressure washers found in 'box stores' or in discount catalogs. These are industrial/professional systems designed and engineered to provide years of dependable service by utilizing the industry's most dependable components.

U-Build Your Own Pressure Washer

Systems Include:
 13 HP Engine
 Low-Oil Shutdown
 Industrial Pump
 2 Wheel Cart
 Unloader
 Thermal Relief
 Pressure Relier

Does not include:
 Injector,
 Hose, Gun, Nozzles
 Minor Assembly Required



\$599.00
 w/ZONGSHEN
4.0 GPM
3500 PSI
 #9920 Net Price

\$849.00
 w/HONDA
4.0 GPM
3500 PSI
 #9869 Net Price

Pressure Gauges

- Stainless Steel case
- 2-1/2" Face
- Bottom 1/4" Mount
- Glycerine filled



PART #	DESCRIPTION	NET PRICE
1130	PRESSURE GAUGE, 3,000 PSI	\$ 9.95
1131	PRESSURE GAUGE, 4,500 PSI	\$ 9.95
1132	PRESSURE GAUGE, 6,000 PSI	\$ 9.95
1133	PRESSURE GAUGE, 10,000 PSI	\$ 9.95

'QC' Pressure Test Tool

- Connect between the unloader and hose
- 6,000 PSI

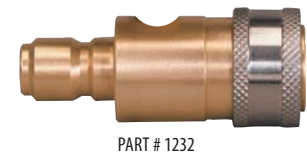

PART #	DESCRIPTION	NET PRICE
1232	QUICK CONNECT TESTER BODY (NO GAUGE)	\$ 5.75
1233	QUICK CONNECT TESTER w/ GAUGE	\$ 11.75

PUMP HEAD PRESSURE TESTER



PART #	PRICE
1229	\$ 49.40

- Not sure why you are losing pressure
- Remove Unloader and attach direct to head
- INSTALL CORRECTLY SIZED NOZZLE
- Hold trigger securely and start engine and see exactly what you pump is capable of producing

A 'MUST HAVE' TOOL!

Are you going to take advantage of our poor math?

This is great if you already have a good pump.

Just 8 bolts is all that is needed to set-up your new washer.

13 HP Honda.....



HONDA ENGINES
with
Low Oil
Shutdown

Industrial Cart =



The Industry's Best Buy!

That's Right!
A \$926.00 VALUE
for the
Low, Low Price
of...

Part Number
9813

$$\$796.87 + \$129.95 = \$549.95 \text{ NET}$$

or - how about this?

This is great if you already have a good pump.

Just 8 bolts is all that is needed to set-up your new washer.

13 HP ZongShen...



with
Low Oil
Shutdown

Industrial Cart =



The Industry's Best Buy!

That's Right!
A \$610.00 VALUE
for the
Low, Low Price
of...

Part Number
9831

$$\$479.95 + \$129.95 = \$349.95 \text{ NET}$$

ALLISON IRON HORSE BELT DRIVE SPACE SAVER SKID



SYSTEM SPECIFICATIONS				
P/N	Engine	Pump	Specs	NET PRICE
PS5535	20 HONDA	GENERAL	5.5 GPM @ 3500 PSI	\$2961.54
PS5550	24 HONDA	GENERAL	5.5 GPM @ 5000 PSI	\$3291.07
PS8035	24 HONDA	GENERAL	8.0 GPM @ 3500 PSI	\$3291.07
PS8530	24 HONDA	GENERAL	8.5 GPM @ 3000 PSI	\$3291.07
PS1220	24 HONDA	GENERAL	12 GPM @ 2000 PSI	\$3291.07

Sewer Jetting Valve Add \$200.00

ALLISON IRON HORSE
SUPER SKID PRESSURE WASHERS

HONDA
ENGINES

5.6 GPM @ 3,500 PSI

NEW FOR 2009

WHITE HOT

SUPER SKID

Introducing...

THE WHITE HOT SERIES

"the hottest hot there is!"

The most advanced coil design in the
PRESSURE WASHER INDUSTRY

Features:

20" HIGH YIELD BTU COIL DESIGN

Special SDC Beckett Burner

20 HP Honda Engine

\$4,995.00

#9950 NET

Add \$700.00 for Generator



There is 'red hot' and then
there is a 'hotter hot...'

WHITE HOT

Sewer Jetting Valves Add \$400.00

HOT WATER SKID

5.6 GPM @ 3,500 PSI

18 HP BRIGGS

Extra Large Fuel Tanks

\$3,995.00

#9827 NET

Add \$700.00 for Generator

Add \$250.00 for horizontal heater
as show on the White Hot Series above.



Sewer Jetting Valve Add \$200.00

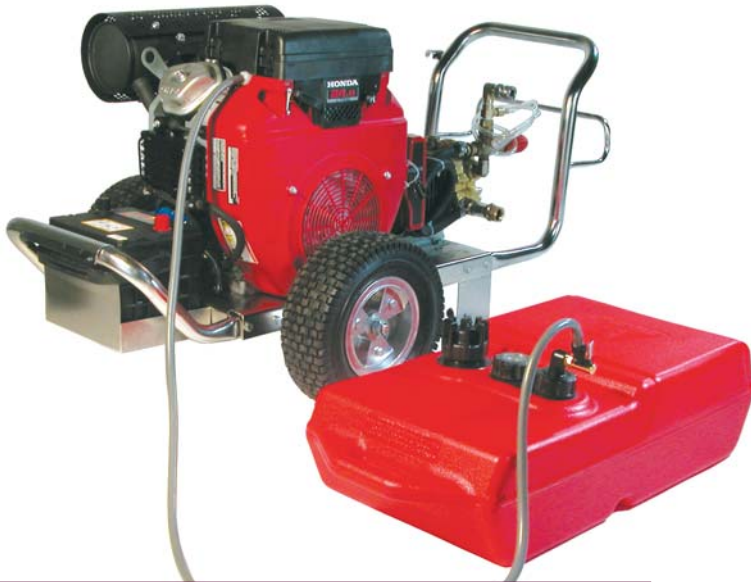

MOELLER
marine products
FUEL TANK

Are you up to Code
or are you using a 5 gallon
'soap bucket' as your Gas Can?
BE SAFE - NOT SORRY
Part Number #4121 \$99.95

This 'Long Run', 9 Gallon Tank will give you hours and hours of run time. When it is empty simply remove the hose from the tank with two fingers, pick it up by the convenient moulded handle

**EXHAUST HOOD
PRESSURE WASHER**

2.1 GPM - 1,500 PSI



All you need is a place to plug it in & then use their

HOT WATER!

**Hi-Temp Kit
Installed**

**#9830
w/Hot Water Kit
\$658.95
NET**

- COMES EQUIPPED WITH:**
- Triplex Pump w/ ceramic plungers
 - Pressure adjustment
 - Built-in detergent suction
 - Motor thermal protector
 - 25' Hose, gun, lance
 - Vari-spray nozzle head
 - Garden hose adapter w/filter
 - 90' GFCI Cord • 115 Volt Motor
- (Guage Not Included)

**ALLISON
24 GALLON
FUEL TANKS**

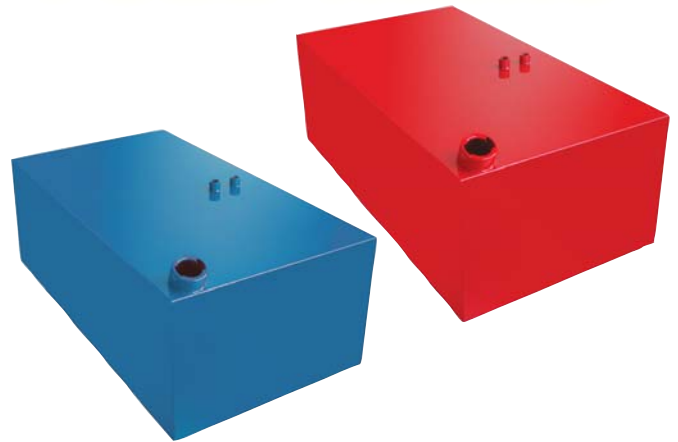

PART #	DESCRIPTION	NET PRICE
9400	RED 24 Gallon Tank for GAS ONLY	\$ 199.95
9401	BLUE 24 Gallon Tank for Diesel & Kerosene	\$ 199.95

Mounting Hardware, Cap and Fuel Pick-up Tube included

Includes 1/4" Botton Drain

31.5" Long 17" Wide 11" High

Up to 10 GPM
Up to 300 PSI

CYCLONE BY: ALLISON

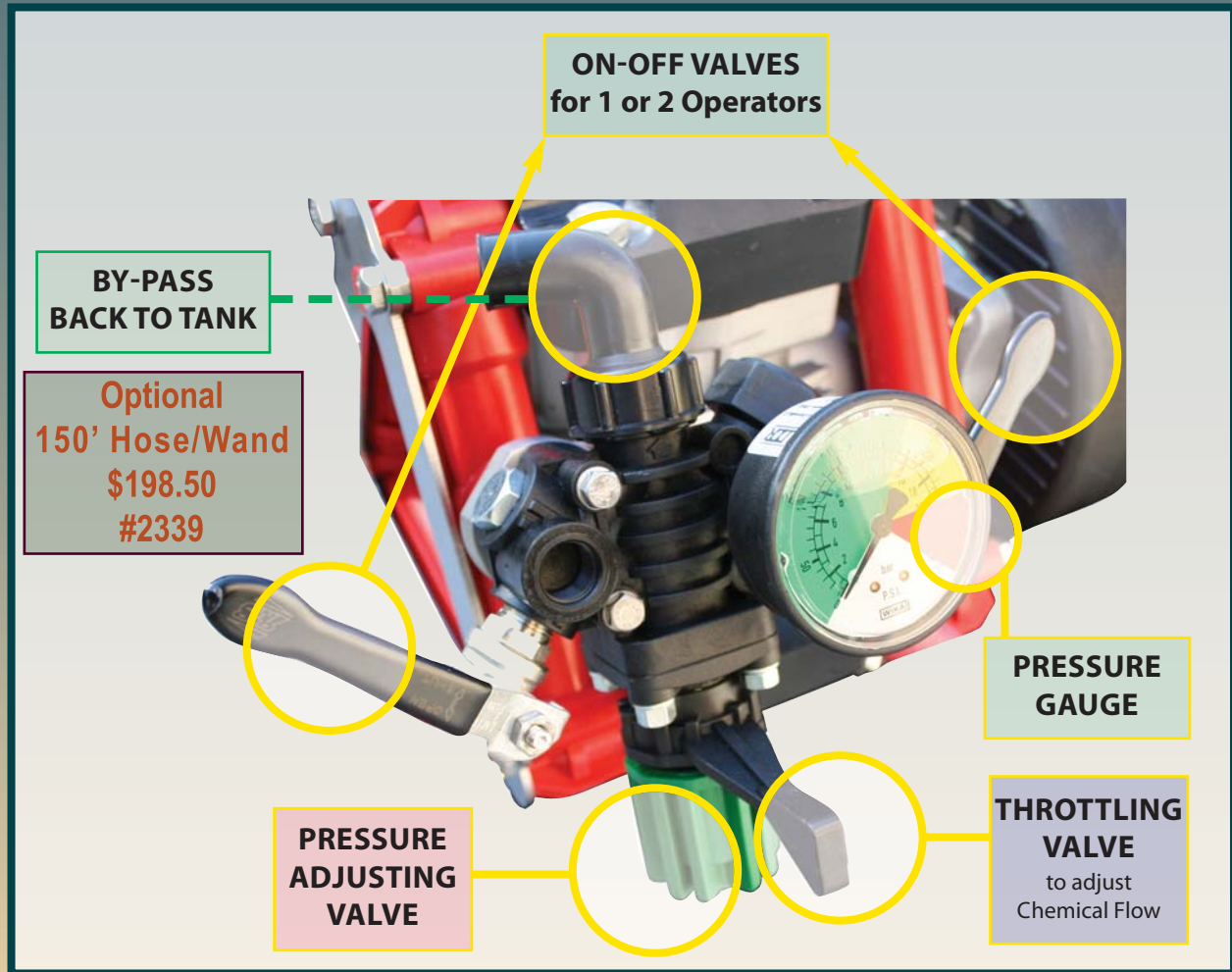

**SORRY! NO TOYS ALLOWED.
...this area is for real CHLORINE PUMPERERS!**

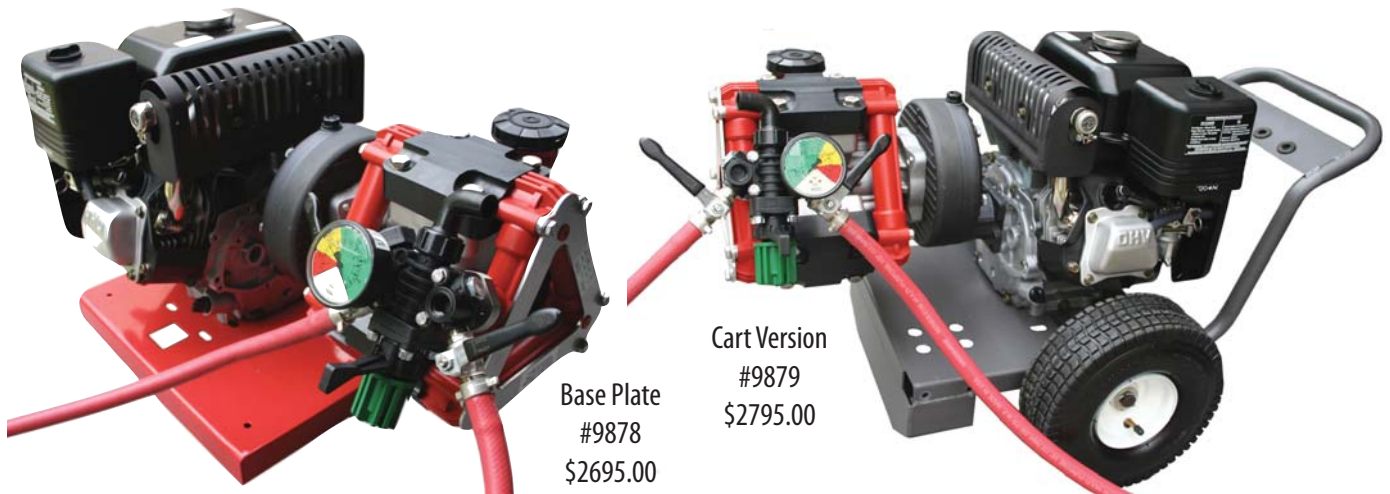

ALLISON IRON HORSE CHEMICAL INDUCTION SYSTEM

12 Volt, High Volume Comes Complete with:

- Allison High Induction Chemical Injector
- 4 additional, easily interchangeable injector nozzles that will allow you to use this system on any pressure washer from 2 GPM thru 10 GPM.
- Induction Pump mounted on a convenient 'hand carry' base plate.
- This System can be detached from the Chemical Injector and utilized to spray undiluted chemical when you purchase Part #1596

*The Injector comes set up with convenient 'quick connects' To be used with pressure type unloaders only.
Not sure what you have? Call!*

PART #	DESCRIPTION	NET PRICE
1595	CHEMICAL INDUCTION SYSTEM, 12V	\$ 179.95
1671	REPLACEMENT INDUCTION PUMP	\$ 99.95
2351	REPAIR KIT - DIAPHRAGM ASSEMBLY	\$ 66.87
2352	PRESSURE SWITCH	\$ 21.92

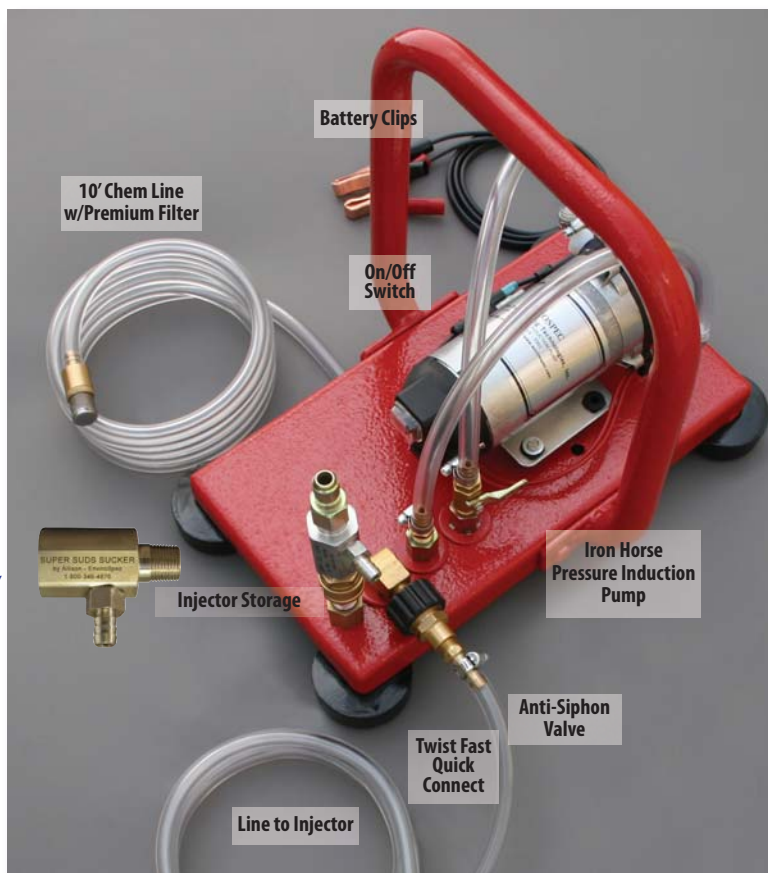

Chemical Applicator Assembly

with Stainless Steel Lance, 100' Poly-braid Hose & Anti-Siphon Valve.

The biggest complaints "EVER" with chemical injectors are:

1. With more than 125' of hose they won't draw chemical!
2. Although it is a 20% injector it doesn't draw enough chemical!
3. I wish I didn't have to use a 'pump-up' to apply bleach!

NOW YOUR HEADACHES ARE BEHIND YOU!

The Allison Chem-Inductor which includes the Allison Super Suds Sucker Injector allows you to draw an incredible amount of chemical.

The following test was based on using a typical injector advertised to draw at 20% (NOT OURS) mounted on a TS-2021 General Pump running at 5.6 GPM.

- | | |
|---|--------------------------|
| 1. With 100' of hose - INJECTOR ONLY | 63 oz. of chem per min. |
| 2. With 100' of hose - WITH CHEM INDUCTOR | 204 oz. of chem per min. |
| Now Check This Out! | |
| 3. With 500' of hose - Competitors 20% Injector | 0 oz. of chem per min. |
| 4. With 500' of hose - WITH CHEM INDUCTOR | 204 oz. of chem per min. |

This means that regardless of which problem you are having you will still induct almost 2 gallons of chemical per minute into the system. Never again will you have to apply the product 2 or 3 times to get the job done. Now you'll be on your way after the first pass. Roof Cleaners using bleach really love this system.

No more 'pump-up' or 'back-pac' sprayers to lug around!



PART #	DESCRIPTION	NET PRICE
1596	CHEMICAL INDUCTION HOSE/WAND ASSEMBLY	\$ 74.95

ALLISON IRON HORSE CHEMICAL INDUCTION SYSTEM

Same as the 1595 System to the left except with a convenient battery compartment.

If you can't get the chemical
to the surface...
...you may as well stay home!
Read the introduction on previous page.

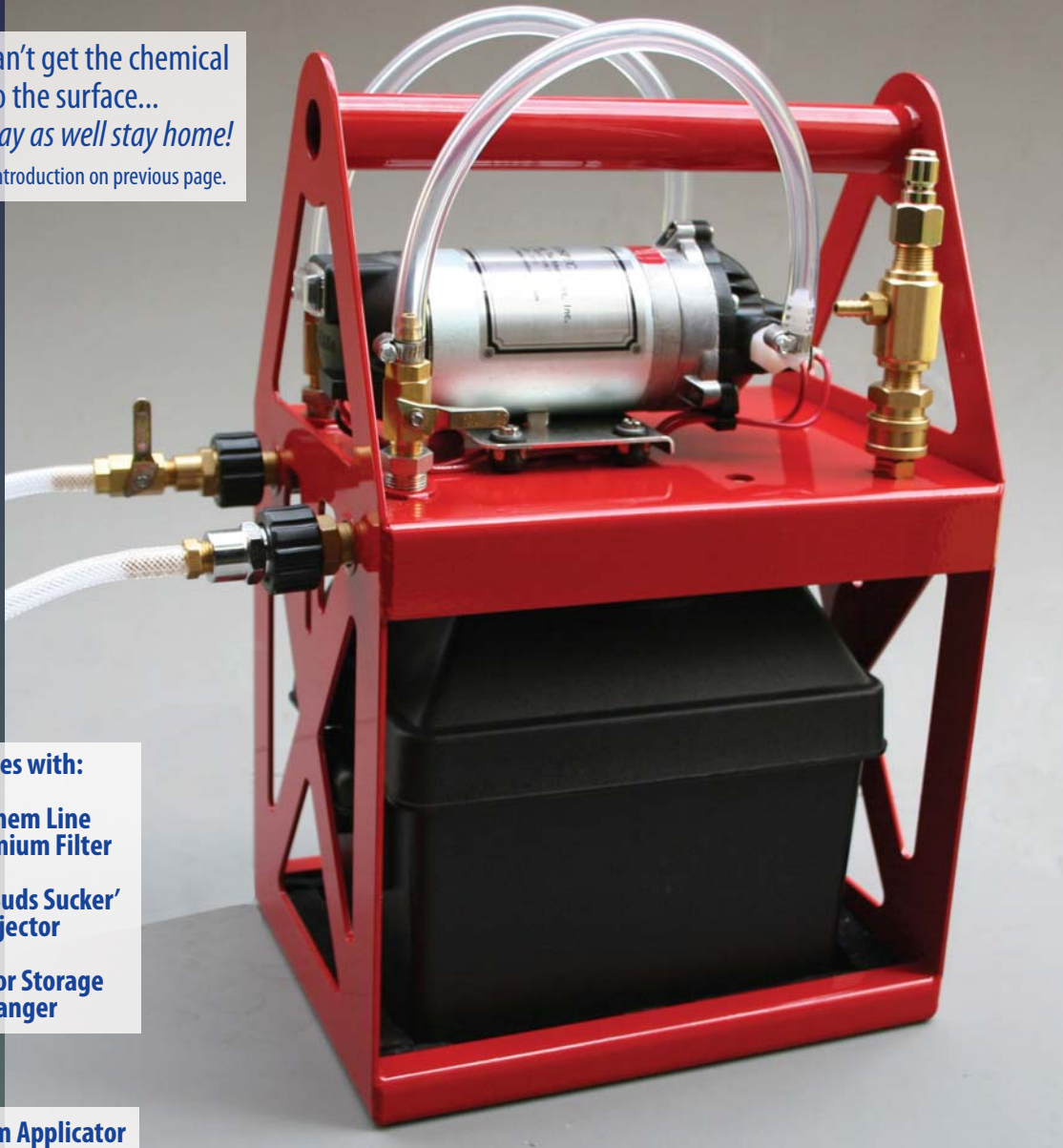

Comes with:

10' Chem Line
w/Premium Filter

'Super Suds Sucker'
Injector

Injector Storage
Hanger

Use Chem Applicator

#1596
on previous page
for spraying
CHLORINE
or
CORROSIVE
EXHAUST HOOD
CLEANERS

*You may need the convenience
of a battery when...
you can't get your rig
to the rear of the house or you
need to remove the system from
the trailer and work inside
of a restaurant.*

**EnviroSpec, Allison Iron Horse and John Allison have
brought more innovations to the industry in the last
20 years than any other company.
*Here is just one more example!***

PART #	DESCRIPTION	NET PRICE
2244	ALLISON CHEM. INDUCTION SYS., 12V, w/Battery Box	\$ 249.95
L = 11.25 / W = 7.00 / H = 17.50 / Weight w/o BATTERY 21.85 Lbs.		



MOSMATIC
FLAT SURFACE CLEANERS

○ SS Guard for extra strength & stability. Adjustable impact range guarantees an efficient cleaning on any type of surface & allows for a side to side sweeping action.

○ Four 2¹/₄" SS castors with custom mounting ensure easy maneuvering even in tight places.

7750

7751

Uses 1/8" MEG Nozzles
Not Included

PART NUMBER	7750	7751	7752	7753	7754	7755
Stainless Steel Housing	21"	30"	21"	21"	21"	30"
Maximum Pressure	4000	4000	4000	4000	7300	4000
Maximum Temperature	250	250	250	250	250	250
Weight	31 lbs	46 lbs	24 lbs	27 lbs	27 lbs	35 lbs
Rotor Arms	2	3	2	2	2	3
Relax Action Gun	Yes	Yes	Yes	Yes	--	Yes
Replacement Swivel	7756	7756	7756	7756	7757	7756
Replacment Castors (1)	7758	7758	--	7759	7759	7759

			P/N	Price
			7750	\$ 801.16
7755	7753	7752	7751	\$ 917.35
	7754		7752	\$ 543.98
			7753	\$ 610.54
			7754	\$ 654.92
			7755	\$ 740.65
			7756	\$ 173.97
			7757	\$ 199.10
			7758	\$ 23.95
			7759	\$ 39.95

LASER DECK FLAT SURFACE CLEANERS

SEMI-PROFESSIONAL LASER DECK



NET PRICE

12 INCH

- Use with an optional spray gun kit
- Attach to a longwand
- Attach to a spray lance



1850	DECK / 2 Nozzles Required	\$ 119.95	1628	GUN & HANDLE KIT	\$ 45.22
------	---------------------------	-----------	------	------------------	----------

LASER DECK ROTARY HEAD BREAKDOWN

WHIRL-A-WAY ROTARY HEAD BREAKDOWN

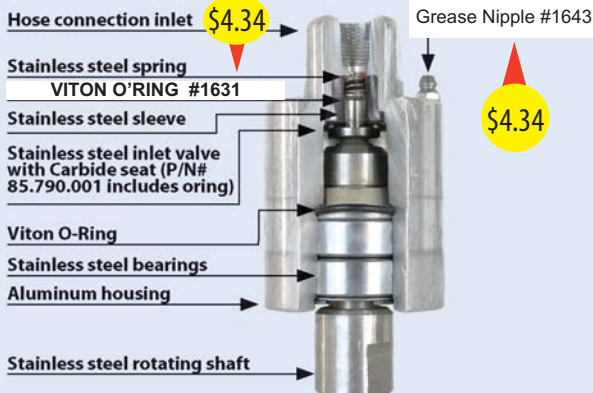

What nozzles should you be using? Look at your lance and see what nozzle you are presently using and divide that number by the number of bars on the surface cleaner.

For example: If you are using a #6 nozzle on your lance on a 3 bar system you will buy 3 #2 Nozzles if you have a 2 bar system you will buy 2 #3 nozzles.

20 INCH

- Two rotary cleaning arms
- Hover action ideal for cleaning rooftops and rough surfaces
- Easy to handle frame is designed for less operator fatigue
- Helps eliminate zebra striping

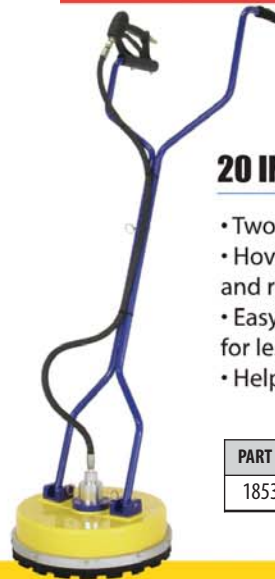

PART #	NOTES:	NET PRICE
1853	2 Nozzles Required	\$ 295.00

2-bar Configuration

Nozzle sizing: Take your normal nozzle and divide it by the number of nozzles required on the unit.

**DECKS
DO NOT
INCLUDE
NOZZLES**

STAINLESS STEEL

20 & 24 INCH

- Three rotary cleaning arms
- Comes with castors ideal for cleaning driveways and other large flat surfaces
- Stainless Steel design for maximum cleaning durability
- Easy to handle frame is designed for less operator fatigue
- Helps eliminate zebra striping



PART #	NOTES:	NET PRICE
1845	20" - 2 Nozzle Bar (No Nozzles)	\$ 434.00
1846	20" - 3 Nozzle Bar (No Nozzles)	\$ 444.00
1847	24" - 2 Nozzle Bar (No Nozzles)	\$ 494.00
1848	24" - 3 Nozzle Bar (No Nozzles)	\$ 500.00



P-SWEEP HYDRO-BROOM

Ours Includes The Nozzles!

PART #	DESCRIPTION	Noz	PRICE
1886	12" Sweep Only	3	\$23.95 NET
1888	16" Sweep Only	4	\$29.95 NET
PART #	DESCRIPTION	Noz	PRICE
1887	12" w/48" Lance & Gun	3	\$57.14
1889	16" w/48" Lance & Gun	4	\$62.64

LASER DECK PARTS

PART #	NOTES:	PRICE
1641	Rotary Head for 12"	\$ 27.42
1632	Rotary Head for 16", 20", 22" & 20"-24" Stainless	\$ 153.79
1633	Rotary Head for 18"	\$ 175.77
1649	Rotary Arm for 12" 2-Bar	\$ 24.12
1645	Rotary Arm for 16" 2-Bar	\$ 32.91
1644	Rotary Arm for 18" 2-Bar	\$ 32.91
1648	Rotary Arm for 20" 2-Bar	\$ 25.22
1647	Rotary Arm for 20" 3-Bar	\$ 43.90
2337	Rotary Arm for 24" 2-Bar	\$34.01
1646	Rotary Arm for 24" 3-Bar	\$ 54.89
1635	Rotary Head Kit for 16", 18", 20", 22", 24"	\$ 149.95
1642	Brush Skirt for 12"	\$ 38.41
1637	Brush Skirt for 20" ABS Plastic	\$ 76.87
1636	Brush Skirt for 16"	\$ 65.88
1638	Brush Skirt for LD20's	\$ 54.89
1639	Brush Skirt for LD24's	\$ 65.88
1634	Caster Wheel for 22"	\$ 21.92
2402	Caster Wheel for 18"	\$ 21.92
1640	Caster Wheel for LD24's	\$ 25.22
1626	Gun for 16"	\$ 25.22
1627	Gun for 18", 20", 24"	\$ 25.22

PSWEEP12 - SMALL



Replacement Nozzle
NOS-05013M \$3.29
(3 Required)

PSWEEP16 - LARGE



Replacement Nozzle
NOS-05013M \$3.29
(4 Required)



Non-Adjustable
Steel Eagle



Our Steel Eagles are equipped with a
DUEBLIN SWIVEL

We recommend a 24" max if you
are using a 5 GPM or less machine.

PART #	NOTES:	PRICE
3751	24" 2-Bar (Noz Not Inc.)	\$ 959.07
3752	24" 3-Bar (Noz Not Inc.)	\$ 983.79
3753	24" 4-Bar (Noz Not Inc.)	\$ 1075.00
3754	30" 2-Bar (Noz Not Inc.)	\$ 988.74
3755	30" 3-Bar (Noz Not Inc.)	\$ 1010.99
3756	30" 4-Bar (Noz Not Inc.)	\$ 1087.64
3757	30" 2-Bar Adj. Height (Noz Not Inc.)	\$ 1208.79
3758	30" 3-Bar Adj. Height (Noz Not Inc.)	\$ 1231.04
3759	30" 4-Bar Adj. Height (Noz Not Inc.)	\$ 1307.69



Adjustable Height
Steel Eagle



Unloader Mounting Block

- Takes the load off of the pump head
- Solid brass
- Rated to 5,000 PSI



PART #	DESCRIPTION	PRICE
1081	MOUNTING BLOCK, 3/8" X 3/8"	\$ 14.23
1082	MOUNTING BLOCK, 3/8" X 1/2"	\$ 14.23
1083	MOUNTING BLOCK, 1/2" X 1/2"	\$ 14.23

K-7 & K-5 Unloader Hi-Spike By-pass Hose

- Flexible 1/4" "hi-spike" line
- Eliminates "surging" on flow actuated unloaders
- 300 PSI working
- 1,200 PSI burst

Eliminates "Surging"



PART #	DESCRIPTION	PRICE
1195	**E** HOSE, HI-SPIKE BY-PASS	\$ 1.65

New from **ENVIROSPEC**
The Industry's "Best Buy"
Ball Valve
6,000 PSI
316 STAINLESS

Ball Valve



PART #	DESCRIPTION	NET PRICE
1666	1/4" FPT X FPT	\$ 29.95
1667	3/8" FPT X FPT	\$ 49.95
1668	1/2" FPT X FPT	\$ 49.95

High Pressure Ball Valves - to 7,500 psi

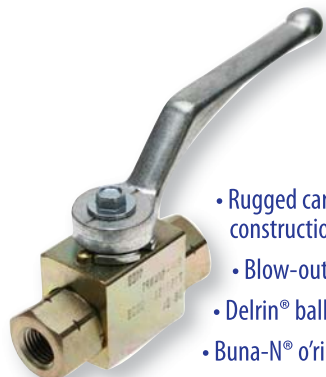

- Rugged carbon steel construction
- Blow-out proof stem
- Delrin® ball seats
- Buna-N® o'rings

PART #	DESCRIPTION	NET PRICE
2-WAY BALL VALVE		
1304	BALL VALVE, 1/4", 7,500 PSI	\$ 19.45
1305	BALL VALVE, 3/8", 7,500 PSI	\$ 19.95
1306	BALL VALVE, 1/2", 5,000 PSI	\$ 22.95
3-WAY BALL VALVE		
1467	3 WAY BALL VALVE, 5000 PSI, 1/4"	\$ 43.90
1468	3 WAY BALL VALVE, 5000 PSI, 3/8"	\$ 43.90
1469	3 WAY BALL VALVE, 5000 PSI, 1/2"	\$ 43.90

3-Way Ball Valve

- For setting up dual chemical feeds
- Solid brass construction
- Arrow-on indicator
- All you need is 3 hose barbs and you are in the dual chemical business



PART #	DESCRIPTION	PRICE
1308	3-WAY BALL VALVE, 1/4"	\$ 29.62

Stainless Steel Ball Valves - 2,000 psi

- Rated to 2,000 psi



- 2-piece, 316 stainless
 - Glass filled Teflon® seats
- TEMP RATING
180° F @ 2,000 PSI
300° F @ 1,000 PSI
350° F @ 300 PSI

PART #	DESCRIPTION	PRICE
2159	STAINLESS BALL VALVE, 2000PSI 1/2"	\$ 32.91
2181	STAINLESS BALL VALVE, 2000PSI 3/4"	\$ 32.91

Industrial Ball Valves

- Rated to 3,000 PSI



- Full flow ports
- All FPT x FPT

PART #	DESCRIPTION	NET PRICE
1303	3/8", CARBON STEEL, 3,000 PSI	\$ 24.12
1669	3/8", BRASS PLATED, 3,000 PSI	\$ 33.95
1670	1/2", BRASS PLATED, 3,000 PSI	\$ 43.95

Chemical Metering Ball Valve

- Solid brass construction
- MPT x 1/4" hose barb
- Can be used in conjunction with our 3-way valve to quickly meter chemicals by simply "throttling" the valve



PART #	DESCRIPTION	PRICE
1307	1/4" Barb x 1/4" MPT, 500 PSI	\$ 14.23

Mini Ball Valve

- Designed for tight places
- 1 3/4" long
- Compact knob
- Rated to 220 PSI



PART #	DESCRIPTION	PRICE
1461	MINI BALL VALVE, 1/8"	\$ 8.74
1462	MINI BALL VALVE, 1/4"	\$ 10.93
1464	MINI BALL VALVE, 3/8"	\$ 10.93
1465	MINI BALL VALVE, 1/2"	\$ 10.93

Mini Ball Valve with Longer Handles

- Rated to 200 PSI
- Packings are chemical resistant
- Extra long handle for easier operation. Especially if you have 'slippery' hands

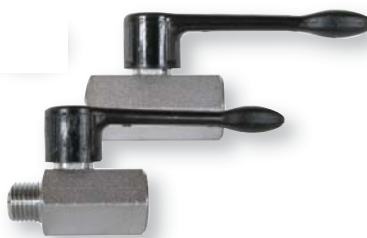

PART #	DESCRIPTION	PRICE
1075	1/4" FPT x FPT	\$ 8.74
1084	1/4" FPT x MPT	\$ 8.74
1122	3/8" FPT x FPT	\$ 8.74
1125	3/8" FPT x MPT	\$ 8.74
1134	1/2" FPT x FPT	\$ 9.84
1147	1/2" FPT x MPT	\$ 9.84

RL-5000 Gun

NEW FOR '09
A 'MUST TRY' GUN



**You will
LOVE THIS GUN!**

GPM: 10.5
PSI: 5000 PSI
TEMP: 320° F

PART #	DESCRIPTION	PRICE
3700	RL-5000 - INDUSTRIAL GUN NET PRICE	\$ 26.95
3701	REPAIR KIT (COMPLETE KIT)	\$ 14.95

HD-1000



GPM: 12
PSI: 4500 PSI
TEMP: 300° F

PART #	DESCRIPTION	PRICE
1226	HD-1000 NET PRICE	\$ 21.95
1227	HD-1000 Chlorine Version	\$ 32.91
1745	REPAIR KIT (CERAMIC BALL ONLY)	\$ 5.49

Front Entry Gun



GPM: 8.0
PSI: 3000 PSI
TEMP: 300° F

PART #	DESCRIPTION	PRICE
1203	Front Entry Gun	\$ 14.47

Arrow Line AL-35

SAFETY YELLOW!



GPM: 8
PSI: 5000 PSI
TEMP: 300° F

PART #	DESCRIPTION	PRICE
1695	ARROW LINE AL-35 NET PRICE	\$ 24.95
1747	REPAIR KIT (CERAMIC BALL ONLY)	\$ 5.49
4404	Complete Kit	\$ 14.95

Hi-Tech Gun No Trigger



GPM: 8
PSI: 4100 PSI
TEMP: 300° F

PART #	DESCRIPTION	PRICE
1223	Triggerless Gun Handle	\$ 17.53

24" 'Close Quarters' - Lance/Gun Assembly

The bent end provides greater surface impact

Dual Valve Assembly when open draws soap and when closed goes to high pressure rinse

Light Weight Stainless Lances and Stainless Valve Body

5,000 PSI Stainless Swivel makes cleaning in close quarters a breeze - rotate the lance 360°

Comfortable, Relax-Grip Hi-Tech 501 Gun for long hours of operation

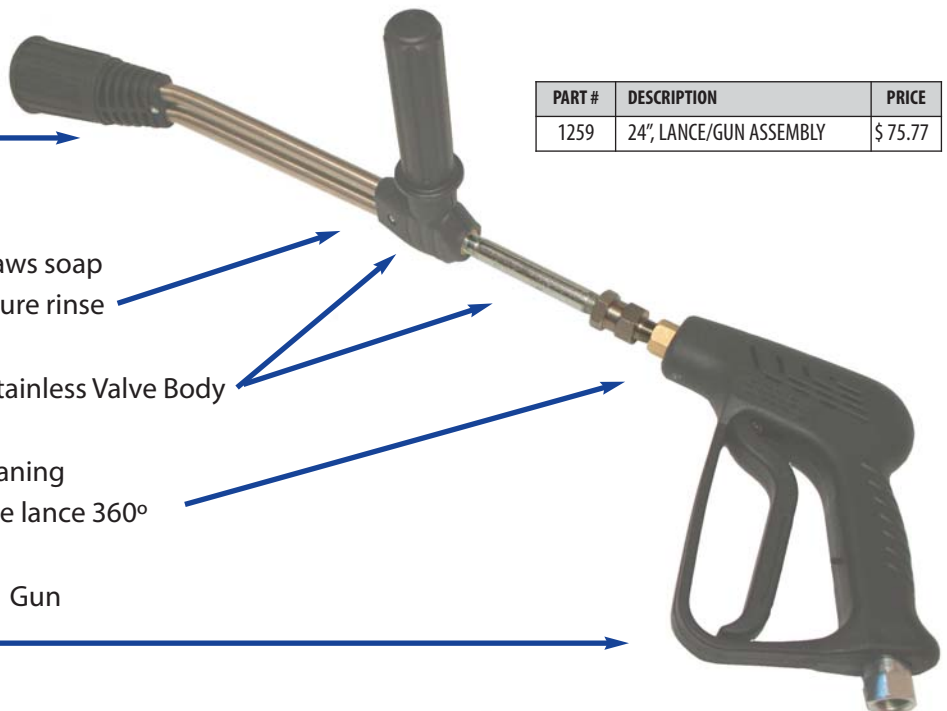

PART #	DESCRIPTION	PRICE
1259	24" LANCE/GUN ASSEMBLY	\$ 75.77

NEW FOR '09

Hi-Tech 5000

AWESOME GUN!



Easy Pull
Relax Grip
Design

GPM: 9
PSI: 5000 PSI
TEMP: 300° F

PART #	DESCRIPTION	PRICE
1208	HI-TECH 5000 NET PRICE	\$ 19.95
1747	REPAIR KIT (CERAMIC BALL ONLY)	\$ 5.49

HI-TECH 501 GUN

Permissible Rating
4,500 PSI - 300°F



Easy Access
Repair Kit Panel

PART #	DESCRIPTION	PRICE
1209	HI-TECH 501 GUN NET PRICE	\$ 14.95
1749	REPAIR KIT (CERAMIC BALL ONLY)	\$ 5.49

FEATURED GUN



Easy Pull
Relax Grip
Design

Hi-Tech 804

GPM: 8
PSI: 4200 PSI
TEMP: 300° F



PART #	DESCRIPTION	PRICE
1225	HI-TECH 804 NET PRICE	\$ 22.95
1749	REPAIR KIT (CERAMIC BALL ONLY)	\$ 5.49

Hi-Tech 4100

Super Easy Pull!

GPM: 13.2
PSI: 4100 PSI
TEMP: 320° F



PART #	DESCRIPTION	PRICE
1204	HI-TECH 4100 NET PRICE	\$ 42.95
1745	REPAIR KIT (CERAMIC BALL ONLY)	\$ 5.49

Hi-Tech 5700

Super Easy Pull!

GPM: 8
PSI: 5700 PSI
TEMP: 320° F



PART #	DESCRIPTION	PRICE
1206	HI-TECH 5700 NET PRICE	\$ 46.95
1744	REPAIR KIT (CERAMIC BALL ONLY)	\$ 5.49

YG 5000

GPM: 11
PSI: 5000 PSI
TEMP: 300° F



Chlorine Version Available!

PART #	DESCRIPTION	PRICE
1220	YG5000 NET PRICE	\$ 24.95
1221	YG5000 Chlorine Version	\$ 32.91
1747	REPAIR KIT (CERAMIC BALL ONLY)	\$ 5.49

**YG4000S
Lenier**

GPM: 10
PSI: 5000 PSI
TEMP: 300° F



PART #	DESCRIPTION	PRICE
1218	YG4000S	\$ 29.62
1747	REPAIR KIT (CERAMIC BALL ONLY)	\$ 5.49
1219	Complete Repair Kit	\$ 15.95

**Hi-Tech 6000
Lenier**

GPM: 10
PSI: 5000 PSI
TEMP: 300° F



PART #	DESCRIPTION	PRICE
1222	HI-TECH 5000 LENIER NET PRICE	\$ 16.95
1747	REPAIR KIT (CERAMIC BALL ONLY)	\$ 5.49

Price Match Guarantee

Find any legitimately advertised item in our catalog elsewhere for less and not only will we meet their price but we will beat it by 5%.

1-800-346-4876

Vendor or Manufacturer 'close-outs', Mosmatic items & Honda engines do not qualify.

In-Line Swivels

- Swivels at max pressure
- 5,000 PSI rated - Adams
- 4,000 PSI rated - NorthStar

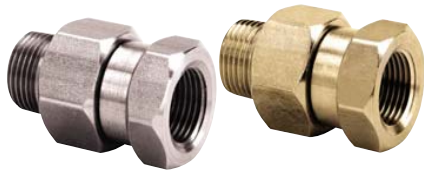

PART #	DESCRIPTION	PRICE
NORTHSTAR BRAND		
1543	IN LINE SWIVEL, 1/4" BRASS	\$ 7.64
1544	INLINE SWIVEL, 3/8" BRASS	\$ 7.64
1545	INLINE SWIVEL, STAINLESS, 1/4"	\$ 10.93
1546	INLINE SWIVEL, STAINLESS, 3/8"	\$ 10.93
J. E. ADAMS BRAND		
1127	INLINE SWIVEL, 1/4" BRASS	\$ 14.23
1291	INLINE SWIVEL, 3/8" BRASS	\$ 16.43
1351	INLINE SWIVEL, STAINLESS, 1/4"	\$ 19.73
1433	INLINE SWIVEL, STAINLESS, 3/8"	\$ 24.12

Don't see what you need?
CALL...
...I'm sure we have it.

Mosmatic Gun Lance Swivel

- Swivels at max pressure
- 4,100 PSI rated
- 10.5 GPM
- 250° F



PART #	DESCRIPTION	NET PRICE
1144	SWIVEL, INLINE, 1/4" F X 1/4" M	\$ 29.95
1145	SWIVEL, INLINE, 1/4" F X 3/8" M	\$ 29.95
1146	SWIVEL, INLINE, 3/8" F X 3/8" M	\$ 29.95

Hose Whips for Trigger Guns

The purpose of the Hose Whip is to extend the life of the quick connects & eliminate leaking. When you are pulling the hose using the gun and lance for leverage you are putting the quick connect in a "metal to metal" bind. When the whip is in place the quick connect coupler and plug will always be pulling in-line with the hose.

PSI: 4,500

Install a whip on inlet side of gun & extend the "quick connect" life ten-fold.



PART #	DESCRIPTION	PRICE
1202	1' WHIP without SWIVEL & "QC"	\$ 12.03
1568	1' WHIP with SWIVEL & "QC"	\$ 27.42

Control Set Unloader

FITS
GENERAL
47 Series
EZ Series
TX Series



GPM: 8.0
PSI: 3,650 PSI
TEMP: 195° F

PART #	DESCRIPTION	PRICE
1110	BOLT ON FOR GENERAL, NO INJECTOR	\$ 76.87
1112	BOLT ON FOR GENERAL WITH INJECTOR	\$ 82.36
1111	REPAIR KIT FOR EITHER	\$ 21.92

THE ORIGINAL AL-607 Unloader



GPM: 8
PSI: 4,500 PSI TEMP: 190° F

PART #	DESCRIPTION	PRICE
1114	AL-607 UNLOADER NET PRICE	\$ 44.95
1113	REPAIR KIT FOR AL-607	\$ 30.71

YU831 Unloader



GPM: 8
PSI: 4,000 PSI
TEMP: 195° F

Multi-Port By-Pass Ports

PART #	DESCRIPTION	PRICE
1104	UNLOADER, PULSAR WITHOUT KNOB	\$ 42.80
1098	REPAIR KIT FOR 1104 & 1099	\$ 21.92

Pulsar Unloader



GPM: 8
PSI: 4,000 PSI
TEMP: 195° F

PART #	DESCRIPTION	PRICE
1099	UNLOADER, PULSAR HP WITH KNOB	\$ 43.90
1098	REPAIR KIT FOR 1104 & 1099	\$ 21.92

K7 Unloader



Flow Actuated

GPM: 2.1-10.8
PSI: 3,500 PSI
TEMP: 165° F



EnviroSpec has installed Special Valving to help reduce Surging while in BY-PASS

PART #	DESCRIPTION	PRICE
1089	2.1-2.9 GPM - K7.0 NET PRICE	\$ 69.95
1090	2.9-4.2 GPM - K7.1 NET PRICE	\$ 69.95
1091	4.2-6.6 GPM - K7.2 NET PRICE	\$ 69.95
1092	6.6-10.8 GPM - K7.3 NET PRICE	\$ 69.95
1789	REPAIR KIT - FITS ALL	\$ 24.12

K5 Unloader



Flow Actuated

GPM: 2.1-10.8
PSI: 3,000 PSI
TEMP: 165° F



High spike by-pass hose is recommended with this unloader to increase by-pass pressure and eliminate 'surging'

PART #	DESCRIPTION	PRICE
1085	2.1-2.9 GPM - K5.0	\$ 71.37
1086	2.9-4.2 GPM - K5.1	\$ 71.37
1087	4.2-6.6 GPM - K5.2	\$ 71.37
1088	6.6-10.8 GPM - K5.3	\$ 71.37
1785	REPAIR KIT - FITS ALL	\$ 24.12

YU-2140 Unloader



The best large volume pressure actuated unloader in the industry!

GPM: 21
PSI: 4,500 PSI
TEMP: 200°



PART #	DESCRIPTION	PRICE
1101	1/2" In/Out/By-pass NET PRICE	\$ 79.95
1102	ADJUSTABLE KNOB	\$ 14.23
1103	Repair Kit	\$ 32.91

K10 Unloader



GPM: 10.8
PSI: 3,600 PSI
TEMP: 165° F

One Size Fits All!



PART #	DESCRIPTION	PRICE
1096	UNLOADER, K-10 FLOW ACTUATED	\$ 76.87
1095	REPAIR KIT FOR K-10	\$ 50.35

VB350 Unloader



GPM: 10.5
PSI: 5,650 PSI
TEMP: 195° F



PART #	DESCRIPTION	PRICE
2032	UNLOADER, VB350	\$ 89.97
2033	REPAIR KIT, VB350	\$ 38.41

Hi-Tech "MV" Unloader

GPM: 8
PSI: 2,000-3,600 PSI
TEMP: 200° F



PART #	DESCRIPTION	PRICE
1118	MV 520 UNLOADER UP TO 2000 PSI	\$ 31.81
1119	MV 540 UNLOADER UP TO 2500 PSI	\$ 37.31
1120	MV 550 UNLOADER UP TO 3600 PSI	\$ 43.90
1121	MV 580 UNLOADER UP TO 4000 PSI	\$ 38.41

K9 Unloader



GPM: 13.2
PSI: 5,800 PSI
TEMP: 195° F

FLOW ACTUATED



PART #	DESCRIPTION	PRICE
1093	UNLOADER, K-9 FLOW ACTUATED	\$ 482.36
1094	REPAIR KIT FOR K-9	\$ 247.25

VB-10 Unloader

SUPER SOFT TOUCH

GPM: 8
PSI: 4,000 PSI
TEMP: 195° F

Feels like a FLOW ACTUATED ...but easy to adjust like a PRESSURE ACTUATED!



PART #	DESCRIPTION	PRICE
1108	UNLOADER, PA10 NET PRICE	\$ 79.95
1109	REPAIR KIT FOR VB-10 NET PRICE	\$ 49.95

A-R BOLT-ON

- Mini for 'XT' & 'XM' Pumps
2-5 GPM to 2600 PSI
- Gymatic for 'XM' & 'RK' Pumps
3-5.5 GPM to 3650 PSI
- Gymatic '3072' 'XM' & 'RK' Pumps
5 GPM to 4000 PSI



PART #	DESCRIPTION	PRICE
2403	Mini without injector	\$ 76.87
2712	Gymatic with fixed injector	\$ 87.86
2301	Gymatic with adjustable injector	\$ 87.95
3072	Gymatic without injector	\$ 79.95

Hudson Float Valve

Preferred over typical float valves.

- No External Moving Parts
- No Float Ball or Arm
- 90° or 150° Max Temp
- All Stainless, Plastic & Nylon
- 1" Inlet - easy installation
- Automatic anti-siphon



PART #	DESCRIPTION	PRICE
1343	VALVE, 90° TEMP. RATING	\$ 43.90
1344	VALVE, 150° TEMP. RATING	\$ 49.40

Plastic Float Valve

- Includes Filter & Pipe
- Max Temperature - 140°F
- Max Pressure - 145 PSI
- 3/4" Inlet



PART #	DESCRIPTION	PRICE
1598	FLOAT VALVE 3/4" PLASTIC, FV10000	\$ 16.43

Plastic Float Tank with Cover

- Max Temp 140°F
- Capacity - 0.8 US Gal.
- Overall Size - 5" x 10" x 8"
- Material - copolymer



PART #	DESCRIPTION	PRICE
1597	FLOAT TANK with LID & BULKHEAD	\$ 10.93

Water Flow Meter

Not sure if the well pump will keep up with your machine? With a garden hose fitting hook this to the faucet and your hose to the tester. Then test the flow before you burn up a pump.



- No more guess work! Know exactly how much water you are supplying to your pump.
- Precise Electronic Monitoring
- Handles from 1-15 GPM
- Use on Inlet Side of Pump - 240° F
- Install permanently or use as test tool

PART #	DESCRIPTION	PRICE
1797	RESETTABLE FLOW METER	\$ 186.76

Brass Float Valve

- Includes Filter & Pipe
- Max Temperature - 140°F
- Max Pressure - 145 PSI
- 3/4" Inlet



PART #	DESCRIPTION	PRICE
1599	FLOAT VALVE 3/4" BRASS	\$ 16.43

Filter for Float Tank

- Plastic & Brass
- 450 Micron
- 3/4" Inlet



PART #	DESCRIPTION	PRICE
1234	FILTER 3/8M PLASTIC - 450 MICRON	\$ 9.84

Industrial Drill Mixer

- If you buy powdered detergent you must have this tool.
- Attach to any heavy duty drill
- High speed chemical mixing thoroughly dissolves chemical



PART #	DESCRIPTION	PRICE
1957	DRILL MIXER, 5 GALLON	\$ 16.43

Stainless Steel Premium Swivel

- 4,100 PSI Working
- 16,000 PSI Burst
- Up to 10.5 GPM
- 200 Degrees



Built for the Long Haul!

Coupler included to attach to 1/2" MPT thread.

PART #	DESCRIPTION	PRICE
1630	STAINLESS STEEL PREMIUM SWIVEL NET	\$ 49.95
1629	REPAIR KIT	\$ 16.43

Heavy Duty Premium Swivel

- 7,000 PSI
- Stainless Steel Insert
- FPT x FPT
- 3/8" FPT inlet for hose
- 1/2" outlet mounts to reel



PART #	DESCRIPTION	PRICE
1592	HD PREMIUM HOSE REEL SWIVEL	\$ 49.40
1593	REPAIR KIT FOR 1592	\$ 14.23

Super Swivel Hose Reel Swivel

- 5,000 PSI
- Grease Fitting for extended life
- FPT x FPT configuration
- When using 3/8" hose order P/N 1463



PART #	DESCRIPTION	PRICE
1463	HOSE REEL SWIVEL, 3/8" X 1/2"	\$ 43.90
2331	HOSE REEL SWIVEL, 1/2" X 1/2"	\$ 43.90
1611	REPAIR KIT	\$ 8.11

Premium High Volume Filter

Use on Allison Iron Horse Equipment!

We recommend that you use this filter on all equipment over 8 GPM.

THE INDUSTRY'S ABSOLUTE BEST FILTER

- Extra large internal chamber
- Extra large ports for maximum flow
- Handles up to 22 GPM
- 50 mesh screen, 1" inlet/outlet



For more information about water filters look in the **TECHNICAL SECTION** of our Website at <http://www.envirospec.com>

PART #	DESCRIPTION	PRICE
1015	PREMIUM HIGH VOLUME WATER FILTER	\$ 38.41

Clear Bowl Water Filter

- 50 mesh filtration
- Heavy duty molded plastic
- Viewable filter media



PART #	DESCRIPTION	NET PRICE
1012	CLEAR BOWL FILTER, 1/2" In/Out	\$ 10.95
1013	CLEAR BOWL FILTER, 3/4" In/Out	\$ 10.95

Direct Mount Water Filter

- Clear view filter mounts directly to pump
- Built-in garden hose connector
- Easily disassembles for cleaning
- Solid brass construction



PART #	DESCRIPTION	PRICE
1010	DIRECT MOUNT FILTER W/O BYPASS	\$ 10.93
1011	DIRECT MOUNT FILTER W/ BYPASS	\$ 13.13

Remote Filter Hanger

This Filter Mounting Hanger can be frame mounted, wall mounted or floor mounted.

It comes with all a 1" Hose Barb and a 1" HEX Nipple and will accomodate any 1" In/Out Filter



- Handles up to a 1" Filter
- Mount to floor, ceiling, wall or frame
- Shown with optional Premium High Volume Filter

PART #	DESCRIPTION	PRICE
2412	Remote Filter Hanger	\$ 29.62

"SUR-TRAP" Y-Trap Strainer

- Solid brass body & cap
- 50 mesh, stainless screen
- Rated to 175 PSI & 195°F



PART #	DESCRIPTION	PRICE
1155	SUR-TRAP, Y-TRAP STRAINER, 3/8"	\$ 8.14
1156	SUR-TRAP, Y-TRAP STRAINER, 1/2"	\$ 8.65
1157	SUR-TRAP, Y-TRAP STRAINER, 3/4"	\$ 11.03
1158	SUR-TRAP, Y-TRAP STRAINER, 1"	\$ 12.62

Compact Water Filter

- Flows to 6 GPM / pressure to 150 PSI
- 50 mesh filter screen, aluminum housing
- Die-cast metal housing with plastic cap
- 1/2" FPT inlet / MPT outlet
- 2 1/4" by-pass ports



Includes Garden Hose Connector

PART #	DESCRIPTION	PRICE
1009	COMPACT WATER FILTER	\$ 12.69

Garden Hose Connectors



PART #	DESCRIPTION	PRICE
1309	SHUT OFF, SINGLE GARDEN HOSE	\$ 4.34
1310	SHUT OFF, DUAL GARDEN HOSE	\$ 5.44
1311	DUAL GARDEN HOSE CONNECTOR	\$ 2.14

Garden Hose Washer

- 50 mesh filter media
- Fits all garden hose inlets
- The first step in proper filtration

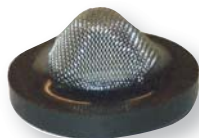

PART #	DESCRIPTION	PRICE
1625	WASHER SCREEN, GARDEN HOSE	\$.32

Garden Hose Connectors

- 3/4" FPT inlet
- MPT outlet filter connector
- Solid brass construction



PART #	DESCRIPTION	PRICE
1019	CONNECTOR, GARDEN HOSE 1/2"	\$ 3.57
1020	CONNECTOR, GARDEN HOSE 3/4"	\$ 4.34

FIRE HYDRANT HOSE

- Fill that 500 Gallon Tank in 2 Minutes Flat!
- Complete with MxM NST Aluminum Connector
- Use PVC Pipe on the Tank End



PART #	DESCRIPTION	PRICE
3336	50' x 2-1/2"	\$ 219.73

Premium Twist Coupler

"Twist Fast"
Connect Coupler,
Double 'O'-ring Seal



Premium Twist Plug

"Twist Fast" Plugs Fit
Double 'O'-ring Couplers

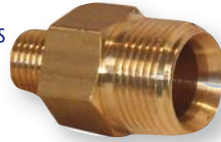

Twist-Fast Replacement 'O' Rings

Fits Twist Fast Couplers



PART #	DESCRIPTION	PRICE
1894	COUPLER, 1/4" FPT, 2 'O' RINGS	\$ 5.44
1895	COUPLER, 1/4" MPT, 2 'O' RINGS	\$ 5.44
1896	COUPLER, 3/8" FPT, 2 'O' RINGS	\$ 5.44
1897	COUPLER, 3/8" MPT, 2 'O' RINGS	\$ 5.44

PART #	DESCRIPTION	PRICE
1890	PREMIUM TWIST FAST PLUG, 1/4" FPT	\$ 2.74
1891	PREMIUM TWIST FAST PLUG, 1/4" MPT	\$ 2.74
1892	PREMIUM TWIST FAST PLUG, 3/8" FPT	\$ 2.74
1893	PREMIUM TWIST FAST PLUG, 3/8" MPT	\$ 2.74

PART #	DESCRIPTION	PRICE
VITON® 'O' RINGS - Chemical Resistance: Severe		
2031	1/4", 400°, BROWN, 50 EACH	\$ 16.48

Twist Fast "Quick Connects"



Ceramic Balls

Aluma-Oxide

- Replacement balls for highly corrosive environments
- Use with Chemical Injectors and Guns

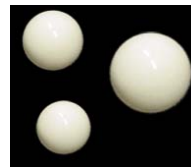

CAUTION: Never use Solvent Spray Lubricants on Quick Couplers. These products cause the o'rings to swell. We recommend white lithium grease when lubrication is required.

PART #	DESCRIPTION	PRICE
1746	CERAMIC BALL, ALUM OXIDE, 1/4"	\$ 5.49
1747	CERAMIC BALL, ALUM OXIDE, 5/16"	\$ 5.49
1744	CERAMIC BALL, ALUM OXIDE, 11/32"	\$ 5.49
1745	CERAMIC BALL, ALUM OXIDE, 13/32"	\$ 5.49
1749	CERAMIC BALL, ALUM OXIDE, 9/32"	\$ 5.49

'Push & Snap' Quick Coupler

The Most Incredible Quick Couplers YOU WILL EVER SEE!

PART #	DESCRIPTION	PRICE
QS4FT	TWIST FAST COUPLER, 1/4" FPT	\$ 2.37
QS4MT	TWIST FAST COUPLER, 1/4" MPT	\$ 2.37
QS8FT	TWIST FAST COUPLER, 3/8" FPT	\$ 2.45
QS8MT	TWIST FAST COUPLER, 3/8" MPT	\$ 2.45
QP4FT	TWIST FAST PLUG, 1/4" FPT	\$ 1.75
QP4MT	TWIST FAST PLUG, 1/4" MPT	\$ 1.75
QP8FT	TWIST FAST PLUG, 3/8" FPT	\$ 1.80
QP8MT	TWIST FAST PLUG, 3/8" MPT	\$ 1.80



This shows the coupler in the 'staged' open position. It remains this way until you push in the plug. When you do the coupler automatically 'snaps' closed.

Here you see just how easy it is to attach a 'quick connect' plug.

Simply insert the plug & push!

When you want the plug to release you will pull down on the collar and the plug will automatically release itself and 'snap' out of the coupler.

PART #	DESCRIPTION	NET PRICE
1901	1/4" FPT	\$ 2.95
1902	3/8" FPT	\$ 4.25

'O' Ring Pick

For removing o'rings from
Check Valves & Quick Connects



PART #	DESCRIPTION	PRICE
1600	'O' RING PICK	\$ 7.64

O-RINGS POPPING OUT?



NOT ANYMORE!

EnviroSpec's new 'Safety-Loc' locks them in place.

Premium Brass Coupler

Brass Coupler with 'Safety Loc System'



Shown: Brass Female Pipe Thread (FPT)

Premium Plated Steel Plugs

"Super Hard" Plated Steel Plug



Shown: Female Pipe Thread (FPT)

PART #	DESCRIPTION	PRICE
QS4FB	1/4" FPT Inlet, 1/4" Coupler Outlet	\$ 2.03
QS4MB	1/4" MPT Inlet, 1/4" Coupler Outlet	\$ 2.03
QS8FB	3/8" FPT Inlet, 3/8" Coupler Outlet	\$ 2.75
QS8MB	3/8" MPT Inlet, 3/8" Coupler Outlet	\$ 2.75

PART #	DESCRIPTION	PRICE
QP4FB	1/4" FPT Inlet, 1/4" Plug Outlet	\$.82
QP4MB	1/4" MPT Inlet, 1/4" Plug Outlet	\$.82
QP8FB	3/8" FPT Inlet, 3/8" Plug Outlet	\$ 1.04
QP8MB	3/8" MPT Inlet, 3/8" Plug Outlet	\$ 1.04

NOT YOUR DIME STORE 'QUICK COUPLERS'



Premium Stainless Coupler

Stainless Coupler with 'Safety Loc System'



Shown: Stainless Steel Male Pipe Thread (MPT)

Premium Stainless Plugs

"Super Hard" Stainless Plug



Shown: Stainless Male Pipe Thread (MPT)

PART #	DESCRIPTION	PRICE
QS4FS	S.S., 1/4" FPT Inlet, 1/4" Coupler Outlet	\$ 3.02
QS4MS	S.S., 1/4" MPT Inlet, 1/4" Coupler Outlet	\$ 3.02
QS8FS	S.S., 3/8" FPT Inlet, 3/8" Coupler Outlet	\$ 4.34
QS8MS	S.S., 3/8" MPT Inlet, 3/8" Coupler Outlet	\$ 4.34

PART #	DESCRIPTION	PRICE
QP4FS	S.S., 1/4" FPT Inlet, 1/4" Plug Outlet	\$ 1.65
QP4MS	S.S., 1/4" MPT Inlet, 1/4" Plug Outlet	\$ 1.65
QP8FS	S.S., 3/8" FPT Inlet, 3/8" Plug Outlet	\$ 1.76
QP8MS	S.S., 3/8" MPT Inlet, 3/8" Plug Outlet	\$ 1.76

Hi-Heat "Quick Couplers"

To hot to handle? These couplers make it easier to disconnect hoses & accessories without burning your fingers



PART #	DESCRIPTION	PRICE
1818	EASY GRIP COUPLER, 1/4" MPT	\$ 3.18
1817	EASY GRIP COUPLER, 1/4" FPT	\$ 3.18
1820	EASY GRIP COUPLER, 3/8" MPT	\$ 3.95
1819	EASY GRIP COUPLER, 3/8" FPT	\$ 3.95

Standard Replacement 'O' Rings

PART #	DESCRIPTION	PRICE
EPDM 'O' RINGS - Chemical Resistance: Moderate		
QOR4E	1/4", 300°, BLACK, 50 EACH	\$ 10.93
QOR8E	3/8", 300°, BLACK, 50 EACH	\$ 10.93
VITON 'O' RINGS - Chemical Resistance: Severe		
QOR4V	1/4", 350°, BROWN, 50 EACH	\$ 14.23
QOR8V	3/8", 350°, BROWN, 50 EACH	\$ 14.23



Severe Duty Premium 'O' Rings

4,000 PSI + Chemical Resistance = SEVERE

These Premium 'O'rings have been recommended as the best for the three major issues of the **PROFESSIONAL CONTRACTOR**:

PRESSURE + HEAT + CHEMICAL

When you combine all 3 environments none hold up as well as the Severe Duty Premium Line.

PART #	DESCRIPTION	PRICE
1960	1/4" SEVERE DUTY 'O' RINGS - 50 EACH	\$ 21.92
1961	3/8" SEVERE DUTY 'O' RINGS - 50 EACH	\$ 24.12

Allison "Super Suds Sucker" Up to 33+% DRAW The Original "Super Suds Sucker" is back!

For those of you to new or young to remember...
...a few years back we designed a chemical injector that would just about suck the bottom out of the pail. Not only that - we were able to put as much as 500' of hose on the machine and still suck as much chemical as most injectors equipped with only 50' of hose.

Here are the two primary advantages of owning a **Super Suds Sucker** and when you think about it - what else is there?

Longevity - This could be the last injector you will ever buy. Most of the ones we built 10 years ago are still 'sucking' strong.

Product to Surface - When we first came out with this product we told people then that "if you cant get the product to the surface you may as well stay at home" - the same holds true today. With a **Super Suds Sucker** you will definitely get the product to the surface.



For over 20 years...

John Allison operated a Mobile Wash company. During this time he recognized that all chemical injectors had one thing in common. None of them could get enough chemical on the surface. Since that time Mr. Allison has designed some of the finest injectors in the industry under the "Super Suds Sucker" logo. However, in the past the manufacturing cost was so high that it made it difficult to bring them to market.

But now you can experience the precision of these high induction injectors at a much more affordable price!

Super Suds Sucker comes with additional nozzles that will handle from 2 to 10 GPM.

Complete with...
quick connects, chemical line & chemical filter.
READY TO GO!

What do most people say when they first try it?
NOW THIS SUCKS!
TRY A **Super Suds Sucker!** TODAY!

PART #	DESCRIPTION	PRICE
1964	ALLISON SUPER SUDS SUCKER INJECTOR	\$ 43.90

Stainless Dual Stage Allison "Suds Sucker"

THE BEST "DRAW RATES" IN THE INDUSTRY DESIGNED BY: **ENVIROSPEC**

- Stainless Steel construction for extended life.
- Draw from one chem or two.
- With both lines in the solution you can expect to draw up to 30% more product.



PART #	DESCRIPTION	PRICE
1139	STAINLESS STEEL DUAL PORT INJECTOR	\$ 98.85

Chem Line & Filter

Comes with our best
Stainless & Brass Chemical Filter
...and 5' of Chemical Line



PART #	DESCRIPTION	PRICE
1154	CHEMICAL FILTER AND LINE	\$ 5.44



These unique features guarantee you
Allison Injectors are the best in the industry!

- Up to 20% draw rate
- Machined Brass
- Ceramic Ball for harsh chemicals & chlorine
- 316 Stainless Nozzle
- Rated to 5,000 PSI
- Viton® O'ring

**20%
DRAW
RATE**

Repair Kit Includes:
1 Ceramic Ball
1 Stainless Spring
1 Viton O'ring

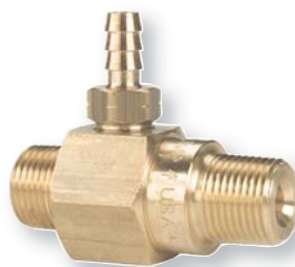

PART #	DESCRIPTION	PRICE
ADJUSTABLE		
1446	ADJUSTABLE WITH CERAMIC BALL, 2-5 GPM NET PRICE	\$ 15.95
1448	ADJUSTABLE WITH CERAMIC BALL, 5-8 GPM NET PRICE	\$ 15.95
NON-ADJUSTABLE		
1441	NON-ADJUSTABLE WITH CERAMIC BALL, 2-5 GPM NET PRICE	\$ 12.95
1443	NON-ADJUSTABLE WITH CERAMIC BALL, 5-8 GPM NET PRICE	\$ 12.95
1439	REPAIR KIT	\$ 7.64

Allison "Suds Sucker" Double Gulp Injectors

As the old saying goes...

27+% DRAW



Adjustable

...if you can't get enough product on the surface you may as well stay at home.

What makes this injector different from the others?

- Solid machined brass
- Ceramic Ball Standard
- Viton O'ring Standard
- Hardened Stainless Nozzle

SHOWN WITH OPTIONAL QUICK CONNECTS

You'll get much more chem draw with both lines in the same solution.

27+% DRAW



Non-Adjustable

PART #	DESCRIPTION	PRICE
NON-ADJUSTABLE		
1737	DUAL PORT, ALLISON, 2-5 GPM	\$ 24.12
1739	DUAL PORT, ALLISON, 5-8 GPM	\$ 24.12
ADJUSTABLE		
1736	DUAL PORT, ALLISON, 2-5 GPM	\$ 27.42
1738	DUAL PORT, ALLISON, 5-8 GPM	\$ 27.42
1740	REPAIR KIT	\$ 10.93

Plastic Chemical Filter

- Weight holds filter on the bottom
- Use with 1/4" or 3/8" chemical tubing
- Corrosion resistant plastic



PART #	DESCRIPTION	PRICE
1150	STRAINER WITH CHECK BALL, PLASTIC	\$ 1.31
1151	STRAINER W/OUT CHECK BALL, PLASTIC	\$ 1.25

Ready-to-Go "Suds Sucker"

Complete with Stainless Quick Connects, 10' of Chemical Line, Our Best Stainless & Brass Chemical Filter.

20+% DRAW

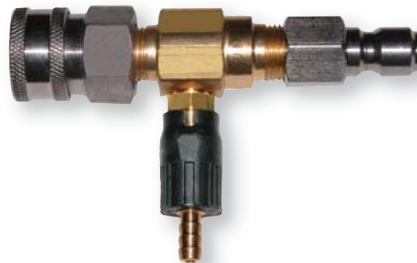

Allison All Stainless Injectors

20+% DRAW



Adjustable



Non-Adjustable

PART #	DESCRIPTION	PRICE
NON-ADJUSTABLE		
1140	NON-ADJUSTABLE, 2-5 GPM	\$ 51.59
1141	NON-ADJUSTABLE, 5-8 GPM	\$ 51.59
ADJUSTABLE		
1142	ADJUSTABLE, 2-5 GPM	\$ 60.38
1143	ADJUSTABLE, 5-8 GPM	\$ 60.38
1439	REPAIR KIT	\$ 7.64

General Pump Chemical Filter

- Polypropylene filter media
- 1/4" hose barb
- Stainless check ball



PART #	DESCRIPTION	PRICE
1152	FILTER WITHOUT CHECK BALL	\$ 4.93

Robo Chem Injector

- Stainless orifice
- Stainless check valve



PART #	DESCRIPTION	PRICE
1135	2.2-4.0 GPM, ROBO CHEM	\$ 26.29
1136	4.0-5.6 GPM, ROBO CHEM	\$ 26.29
1137	5.6-10.9 GPM, ROBO CHEM	\$ 28.52
1138	REPAIR KIT	\$ 9.84

Premium Chemical Filter *By Far The Best!*

- Solid Stainless and Brass construction
- Larger than others - allows more chemical flow
- Removable, internal "check" prevents chems from back flowing.



PART #	DESCRIPTION	PRICE
1153	CHEMICAL STRAINER, PREMIUM	\$ 2.49

Stainless Chemical Filter

- 50 mesh, removable stainless screen
- Heavy duty one piece construction
- 1/4" hose barb
- Stainless check ball
- Approx. one third the size of 1153



PART #	DESCRIPTION	PRICE
1149	CHEM FILTER, STAINLESS	\$ 1.92

Ask for our Technical Service School & Seminar schedule

NOTE: Next to most of the part numbers there is a letter. This letter will cross to the chart below to give you the rated pressure. Brass Fittings should not be used in places where the pressure will exceed 300 PSI.

“ _ ” = WORKING PRESSURE

“A” = 6,000 PSI - (18,000 PSI Burst Pressure)

“B” = 5,000 PSI - (15,000 PSI Burst Pressure)

“C” = 4,500 PSI - (13,500 PSI Burst Pressure)

“D” = 4,000 PSI - (12,000 PSI Burst Pressure)

“E” = 3,000 PSI - (9,000 PSI Burst Pressure)

THE ONLY FITTINGS WE RECOMMEND!

SUPER HEAVY DUTY

PRESSURE WASHER FITTINGS

	HOSE BARBS Barb X MPT
1720 \$1.08	1/4 x 1/4 Brass
1721 \$1.70	1/4 x 3/8 Brass
1726 \$3.85	1/4 x 1/2 Brass
1723 \$1.08	3/8 x 1/4 Brass
1724 \$1.57	3/8 x 3/8 Brass
1722 \$2.75	3/8 X 1/2 Brass
1729 \$2.86	5/8 x 1/2 Brass
1725 \$1.70	1/2 x 3/8 Brass
1727 \$3.85	1/2 x 1/2 Brass
1728 \$4.12	1/2 x 3/4 Brass
1731 \$3.66	3/4 x 3/4 Brass
1730 \$2.75	3/4 x 1/2 Brass

	BRASS HOSE BARB MENDER	
9070	\$1.65	1/4"
9071	\$1.65	3/8"
9072	\$1.65	1/2"
9073	\$2.75	3/4"

	REDUCING NIPPLE
9013 A \$.99	3/8 x 1/4
9015 A \$1.56	1/2 x 1/4
9016 A \$1.63	1/2 x 3/8
9018 A \$4.12	3/4 x 1/2

	PIPE NIPPLE
9056 A \$4.92	1/4 x 2
9057 A \$5.89	1/4 x 3
9058 A \$6.70	1/4 x 4
9059 A \$6.64	3/8 x 2
9060 A \$6.75	3/8 x 3
9061 A \$9.12	3/8 x 4
9062 A \$4.02	1/2 x 2
9063 A \$5.41	1/2 x 3
9064 A \$6.55	1/2 x 4
9065 A \$8.35	1/2 x 5
9066 A \$8.66	1/2 x 6
9067 A \$7.25	3/4 x 2
9068 A \$8.57	3/4 x 3
9069 A \$9.67	3/4 x 4

	PLUG	
9051 A	\$.53	1/4"
9052 A	\$2.09	3/8"
9053 A	\$2.09	1/2"
9054 A	\$2.09	3/4"

	ADAPTER FPT X MPT
9000 A \$2.86	3/8 x 1/4
9002 B \$3.05	1/2 x 3/8
9003 D \$5.25	3/4 x 1/2

	TEE
9035 B \$3.10	1/4"
9036 C \$3.91	3/8"
9037 E \$6.33	1/2"
9038 E \$11.99	3/4"

	STREET TEE FPT X FPT X MPT
9047 E \$3.30	1/4"
9048 C \$4.64	3/8"
9049 E \$6.44	1/2"
9050 E \$9.89	3/4"

	CROSS 4-WAY - FPT
9039 B \$6.92	1/4"
9040 C \$10.92	3/8"
9041 E \$11.32	1/2"
9038 E \$11.99	3/4"

	REDUCING BUSHING MPT X FPT
9043 A \$1.10	3/8 x 1/4
9044 A \$1.21	1/2 x 1/4
9045 A \$1.21	1/2 x 3/8
9046 A \$1.54	3/4 x 1/2

	HEX NIPPLE
9012 A \$2.20	1/4"
9014 A \$2.20	3/8"
9017 A \$2.20	1/2"
9019 A \$2.20	3/4"

	90° STREET ELBOW FPT X MPT
9020 B \$2.57	1/4"
9021 C \$3.05	1/4" x 3/8"
9022 C \$2.92	3/8"
9023 E \$5.45	1/2" x 3/8"
9024 E \$4.26	1/2"
9025 E \$8.09	3/4" x 1/2"
9026 E \$7.52	3/4"

	45° STREET ELBOW FPT X MPT
9031 \$2.55	1/8"
9032 \$2.57	1/4"
9033 \$3.38	3/8"
9034 \$4.13	1/2"

	90° ELBOW FPT X FPT
9027 B \$2.31	1/4"
9028 C \$2.81	3/8"
9029 E \$4.84	1/2"
9030 D \$6.82	3/4"

	COUPLERS
9004 A \$1.21	1/4"
9006 A \$1.56	3/8"
9009 B \$2.02	1/2"
9011 B \$3.10	3/4"

	REDUCING COUPLING
9007 B \$2.68	1/2 X 3/8
9010 D \$4.26	3/4 x 1/2

Safety Relief Valve

- Fully adjustable
- Rated up to 6,000 PSI
- Handles up to 12 GPM
- Rated to 195°F



PART #	DESCRIPTION	NET PRICE
1123	RELIEF VALVE, 3/8" MPT	\$ 9.95
1126	RELIEF VALVE, 3/8 W/BARB	\$ 19.73

Easy Start Valve

- Installs on the high pressure (outlet) side of the pump and relieves the "back-pressure" during start-up.



PART #	DESCRIPTION	PRICE
1124	EZ START VALVE	\$ 13.13

Pump Thermal Protector

- Installs on the inlet side of the pump
- When by-pass water reaches 145° the valve opens to allow heated water to escape to atmosphere.
- Only recommended for machines being force-fed from a water source. If you are running a gas engine and pulling from a tank you should be using an Allison Engine Terminator.



PART #	DESCRIPTION	PRICE
1076	1/2" w/ PLASTIC BARB	\$ 10.93
1062	3/8" w/ BRASS BARB	\$ 14.23

Burst Disc

THAT COULD SAVE A LIFE, MAYBE YOURS!

If you are standing around with the gun in the off position and the burner fails to "shut down" be prepared for a serious explosion. Coils will generally blow at around 20,000 PSI and when they do chances are someone will get seriously hurt or killed. At that pressure the coil and tank will rupture and come apart.



- Pre-set to "BURST" at 8,000 psi

PART #	DESCRIPTION	PRICE
1106	BURST DISC, 8,000 PSI	\$ 27.42

Exhaust Hood Swivels, Non-Adjustable

MOSMATIC
HOT WATER SWIVELS

- Fixed nozzle positioning ideally suited to be dropped down the exhaust hood.

To order the correct nozzles take the nozzle that you are presently using and divide it by the number of nozzles required by the Exhaust Hood Swivel you are ordering. For example: If you typically use a #6 nozzle such as a #1506 and you are buying a 3-Nozzle Swivel you will order 3 each #2 nozzles such as a #1502.



These swivels require
1/8" MEG Nozzles
Sold Separately

PART #	DESCRIPTION	PRICE
2-NOZZLE HIGH SPEED		
1519	FIXED, 3", 2 NOZZLE	NET PRICE \$ 239.95
1520	FIXED, 6", 2 NOZZLE	NET PRICE \$ 249.95
1521	FIXED, 12", 2 NOZZLE	NET PRICE \$ 259.95
1522	FIXED, 16", 2 NOZZLE	\$ 303.71
1523	FIXED, 20", 2 NOZZLE	\$ 336.29
1524	FIXED, 24", 2 NOZZLE	\$ 344.43
3-NOZZLE HIGH SPEED		
1531	FIXED, 3", 3 NOZZLE	\$ 294.18
1532	FIXED, 6", 3 NOZZLE	\$ 305.55
1533	FIXED, 12", 3 NOZZLE	\$ 311.10
1534	FIXED, 16", 3 NOZZLE	\$ 316.64
1535	FIXED, 20", 3 NOZZLE	\$ 349.79
1536	FIXED, 24", 3 NOZZLE	\$ 355.33

Exhaust Hood Swivels, Adjustable

MOSMATIC
HOT WATER SWIVELS

- Adjustable nozzle positioning to allow the swivel to pull itself.

To order the correct nozzles take the nozzle that you are presently using and divide it by the number of nozzles required by the Exhaust Hood Swivel you are ordering. For example: If you typically use a #6 nozzle such as a #1506 and you are buying a 3-Nozzle Swivel you will order 3 each #2 nozzles such as a #1502.



These swivels require
1/8" MEG Nozzles
Sold Separately

PART #	DESCRIPTION	PRICE
2-NOZZLE HIGH SPEED		
1525	ADJUSTABLE, 3", 2 NOZZLE	NET PRICE \$ 269.95
1526	ADJUSTABLE, 6", 2 NOZZLE	NET PRICE \$ 289.95
1527	ADJUSTABLE, 12", 2 NOZZLE	NET PRICE \$ 299.95
1528	ADJUSTABLE, 16", 2 NOZZLE	NET PRICE \$ 299.95
1529	ADJUSTABLE, 20", 2 NOZZLE	NET PRICE \$ 329.95
1530	ADJUSTABLE, 24", 2 NOZZLE	NET PRICE \$ 339.95
3-NOZZLE HIGH SPEED		
1537	ADJUSTABLE, 3" 3 NOZZLE	\$ 333.66
1538	ADJUSTABLE, 6" 3 NOZZLE	\$ 344.87
1539	ADJUSTABLE, 12" 3 NOZZLE	\$ 377.96
1540	ADJUSTABLE, 16" 3 NOZZLE	\$ 386.30
1541	ADJUSTABLE, 20" 3 NOZZLE	\$ 419.63
1542	ADJUSTABLE, 24" 3 NOZZLE	\$ 427.82

ENVIROSPEC'S
Soap for Hope CHARITIES

EnviroSpec donates 100% of the after tax profits from our Chemical Sales to Animal Charities such as Suzie's Friends Animal Shelter, The Humane Society of the United States, ASPCA, Local Animal Shelters, Humane Societies and Rescues in other areas of the country and the Jekyll Island AristoCAT Spay/Neuter Program.

Please consider helping a Shelter or Rescue in your area.
It's a great feeling knowing that you have helped
an abandoned, helpless & hungry animal.

Meet Suzie, who inspired John & Shelley Allison's latest project, Suzie's Friends. Suzie lived on her own with a dislocated leg for over 2 years until she was rescued by John and Shelley. When they found her it was too late to save the leg, but just in time to make sure that the rest of Suzie's life was a little easier than her first 3 years. When she was once dragging her leg trying to find something to eat or a warm place out of the rain and cold and living every moment of her life in pain, Suzie now lives the life that every animal dreams of.

Won't you please help a stray?

Too Few do.

Suzie's
Friends

<http://www.suziesfriends.org>



• **Suzie's Friends**

The mission of Suzie's Friends is to provide a special no-kill, no-cage sanctuary in South Georgia where the hungry are fed, the homeless are sheltered, and the abused and abandoned are provided care. Unfortunately we do this in a community whose governments spend nothing on caring for these animals. Suzie's Friends is for both fidos and felines alike who are less fortunate than other pets. No, the pictures that we see are not of "Princess" on a pillow with a diamond studded collar. Our little friends are wandering the streets looking for something to eat, or lying in a ditch on the side of the road starving to death and sick as a result of abuse and neglect. Since we get little in the way of financial help it is your purchases that keep them alive.

SAVE 10% ON E-MAIL/FAX ORDERS UNLESS 'NET' PRICE APPEARS

Now you see why more and more
PRESSURE WASHER OWNERS

Call 1-800-346-4876



Drum Siphon Pump

- The industry's #1 selling siphon pumps
- Each will pump up to 7 gallons per minute
- Can be cut down to fit 5 gallon pails

**"Lid-Off"
Pail Lid Remover**



- Safely remove lids from buckets

PART #	DESCRIPTION	NET PRICE
1650	SIPHON PUMP, HEAVY DUTY	\$ 9.95
1781	SIPHON PUMP, EXTREME DUTY	\$ 15.95

PART #	DESCRIPTION	PRICE
1652	PAIL LID REMOVER	\$ 5.22

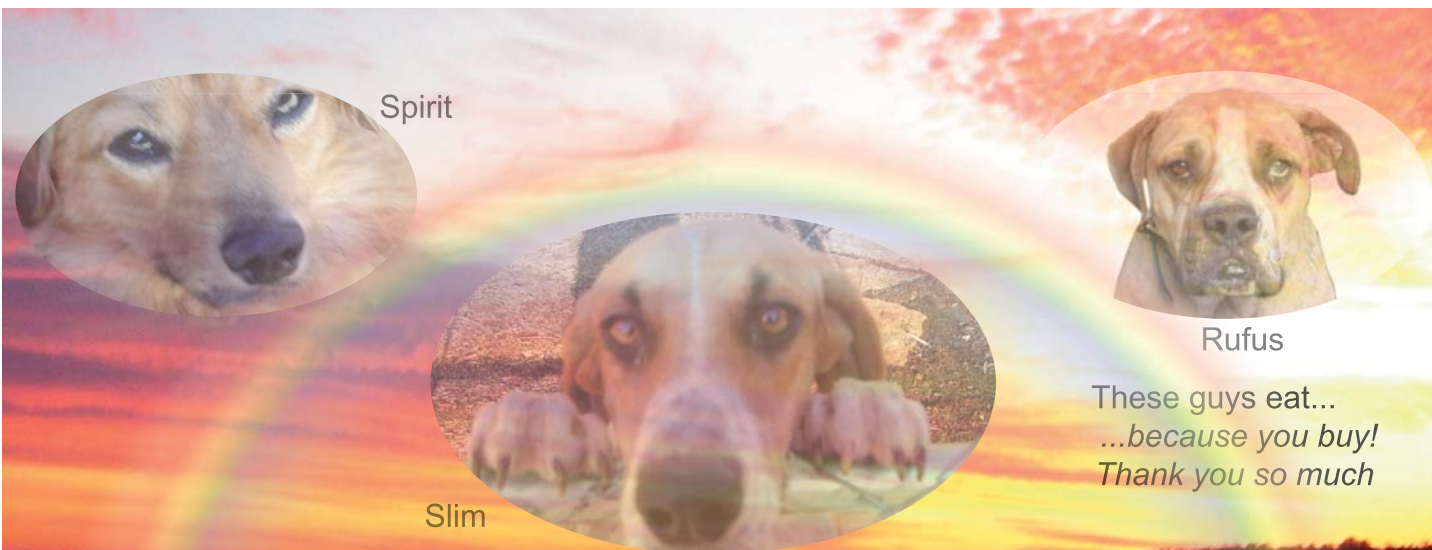

Spirit

Rufus

Slim

These guys eat...
...because you buy!
Thank you so much

"The greatness of a nation and its moral progress can be judged by the way its animals are treated." ~ Mahatma Gandhi

ENVIROSPEC

**High Pressure
Foam Cannon**



- Throws thick foam for deep cleaning
- Works on systems up to 6.6 GPM
- Rated to 3,000 PSI
- Order with or without bottle

PART #	DESCRIPTION	PRICE
1272	FOAM CANNON, NO BOTTLE	\$ 51.59
1273	FOAM CANNON W/TANK	\$ 62.58

**Garden Hose
Quick Connects**

Industrial Quality
Solid Brass Construction



PART #	DESCRIPTION	PRICE
1016	QUICK CONNECT PLUG	\$ 2.14
1017	QUICK CONNECT COUPLER	\$ 3.13
1018	QUICK CONNECT, COMPLETE SET	\$ 4.48

"Sludge Sucker"

- Place the black foot into the flooded area. Connect the pressure washer hose to the foot. Stretch out the blue discharge hose and pull the trigger on the pressure washer and watch the flooded area disappear.



PART #	DESCRIPTION	PRICE
1348	SLUDGE SUCKER	\$ 50.49

Flex Lances

- Flexes 180° and returns.
- Great for wheel wells on autos.
- 18" long x 1/4" MPT in & out on plated steel.
- 1/4" MPT In & 1/4" FPT out on stainless.
- Max pressure 2,500 PSI



PART #	DESCRIPTION	PRICE
1795	FLEXIBLE LANCE PLATED STEEL	\$ 9.07
1796	FLEX LANCE, STAINLESS STEEL	\$ 13.13

Chemical Metering Valve

- Stainless & Brass
- Rated to 4,000 PSI
- Viton gland seals
- Heavy duty brass bar stock
- Panel mountable



PART #	DESCRIPTION	NET PRICE
2447	CHEMICAL METERING VALVE	\$ 9.95

Chemical "L" Metering Valve

- Up to 440 PSI
- Up to 3 GPM
- Up to 100 F



PART #	DESCRIPTION	NET PRICE
1317	METERING VALVE 90 DEGREE	\$ 15.95

Chemical "T" Metering Valves

- Up to 440 PSI
- Up to 3 GPM
- Up to 100 F



PART #	DESCRIPTION	NET PRICE
1289	1/4" MPT X 1/4" MPT	\$ 14.95
1290	1/4" FPT X 1/4" FPT	\$ 14.95

Schedule 80 Aluminum Lances

96" lances are sold with 2 each, 48" sections with a special lance coupler



PART #	DESCRIPTION	PRICE
WITH GRIPS & 1/4" MPT INLET/OUTLET		
1354	24" LANCE W/GRIP	\$ 9.84
1356	36" LANCE W/GRIP	\$ 10.93
1358	48" LANCE W/GRIP	\$ 14.23
1360	60" LANCE W/GRIP	\$ 16.43
1364	96" LANCE W/GRIP	\$ 20.82
WITHOUT GRIPS & 1/4" MPT INLET/OUTLET		
1353	24" ALUMINUM LANCE NO GRIP	\$ 5.44
1355	36" ALUMINUM LANCE NO GRIP	\$ 7.64
1357	48" ALUMINUM LANCE NO GRIP	\$ 9.84
1359	60" ALUMINUM LANCE NO GRIP	\$ 12.03
1361	72" ALUMINUM LANCE NO GRIP	\$ 14.23
1363	96" ALUMINUM LANCE NO GRIP	\$ 18.63

Lance Couplers

- Keeps lances from breaking at thread level.
- The stabilizing shoulder is recessed deep into the coupling before the thread starts.

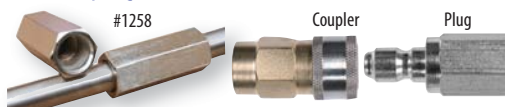

PART #	DESCRIPTION	PRICE
1021	PLUG, PLATED 1/4" FTP	\$ 1.09
1022	COUPLER, PLATED 1/4" FTP	\$ 3.29
1023	PLUG, STAINLESS 1/4" FTP	\$ 2.63
1024	COUPLER, STAINLESS 1/4" FTP	\$ 4.60
1258	DEEP SHOULDER LANCE COUPLING	\$ 3.24

Gutter Sweep

- 12" gutter cleaner • 1/4" "QC" connectors
- "Attach it to the end of your lance, snap in your favorite nozzle, position it over the gutter ...and pull the trigger!"



PART #	DESCRIPTION	PRICE
1814	GUTTER SWEEP - Standard Quick Connects	\$ 9.84
1815	GUTTER SWEEP - Twist Fast QC Inlet	\$21.92

Stainless & Zinc Plated Lances

All Lances have Grips
1/4 MPT In/Out



PART #	DESCRIPTION	PRICE
ZINC PLATED - 1/4" MPT IN/OUT		
1236	STRAIGHT, 12"	\$ 4.34
1237	STRAIGHT, 24"	\$ 4.34
1238	STRAIGHT, 36"	\$ 5.44
1242	15° BENT, 36"	\$ 10.93
1239	STRAIGHT, 48"	\$ 7.64
1243	15° BENT, 48"	\$ 14.23
1240	STRAIGHT, 60"	\$ 12.03
1244	15° BENT, 60"	\$ 19.73
1241	STRAIGHT, 79"	\$ 14.23
1245	15° BENT, 79"	\$ 21.92
STAINLESS STEEL - 1/4" MPT IN/OUT		
1246	STRAIGHT, 24"	\$ 8.74
1247	STRAIGHT, 36"	\$ 14.23
1251	15° BENT, 36"	\$ 17.53
1248	STRAIGHT, 48"	\$ 21.92
1252	15° BENT, 48"	\$ 28.52
1249	STRAIGHT, 60"	\$ 25.22
1253	15° BENT, 60"	\$ 27.42
1250	STRAIGHT, 79"	\$ 31.81
1254	15° BENT, 79"	\$ 32.91

SPRAY-FLEX Lances

- Holds Shape up to 5000 PSI

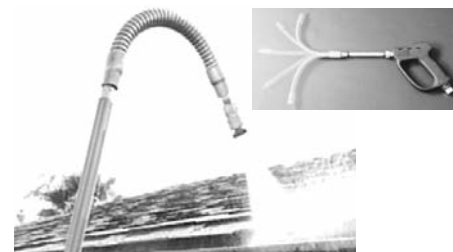

PART #	DESCRIPTION	PRICE
1691	Rated to 3,000 PSI	\$ 52.69
1692	Rated to 5,000 PSI	\$ 58.19

Lance Side Handle & Grip

These grips fit all 1/4" lances without molded grips as well as any 1/4" pipe.



PART #	DESCRIPTION	PRICE
1260	ADJUSTABLE SIDE HANDLE WITH NUT	\$ 3.29
1612	VENTED GRIP FITS 1/4" LANCE	\$ 5.66

Zinc Lance with Diverter Trigger

- Nozzle Protector
- Pull the Trigger to Draw Soap
- Release the Trigger for High Pressure
- 1/4" MPT inlet - 1/8" discharge pipes

- **TEMP:** 300°F
- **GPM:** 10.5
- **PSI:** 3,600



PART #	DESCRIPTION	PRICE
1235	DUAL LANCE - WITH DIVERTER TRIGGER	\$ 49.40

Premium Series Stainless

- 1/4" MPT inlet
- 1/4" outlets draws more chemical



FOR HIGHLY CORROSIVE ENVIRONMENTS

- **TEMP:** 300°F
- **GPM:** 10.5
- **PSI:** 4,100

"1263" attach to gun for "close quarter" work such as car lots.

PART #	DESCRIPTION	PRICE
1263	11 INCH DUAL LANCE, STAINLESS STEEL	\$ 43.90
1264	27 INCH DUAL LANCE, STAINLESS STEEL	\$ 47.20
1265	37 INCH DUAL LANCE, STAINLESS STEEL	\$ 48.30
1262	42 INCH DUAL LANCE, STAINLESS STEEL	\$ 49.40

Dual Lances

new 'deluxified' ready-to-go Lances

- Zinc-Plated Steel
- General/InterPump Brand
- 1/4" MPT inlet - 1/8" discharge pipes



36" Dual Lance, Zinc-Plated Steel with "Quick Connects" installed for pressure & soap nozzle.....Part #1256

PART #	DESCRIPTION	PRICE
1255	DUAL LANCE, ZINC PLATED , 36"	\$ 60.38
1256	DUAL LANCE, ZINC PLATED 36", w/ QUICK CONNECTS	\$ 65.88
1257	DUAL LANCE, ZINCE PLATED, 72"	\$ 76.87

Telescoping 'Long Wands'

RATED TO 4,000 PSI

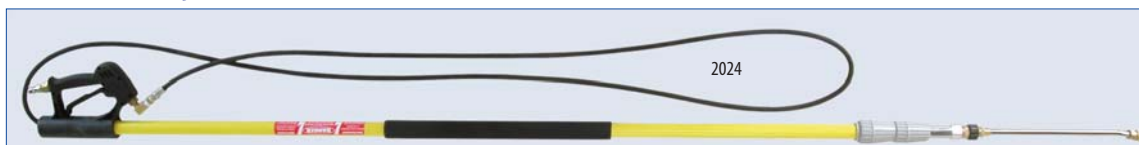

PART #	DESCRIPTION	PRICE
2024	3 Section to 24' with 3/8" Hose NET PRICE ▶	\$ 99.95
2029	Gun fits 2024	\$ 27.42
1815	Gutter Sweep with Twist Type Connects	\$ 21.92
2028	'Load Bearing' Belt / Harness	\$ 16.50

We have been selling long wands since the first ones came out. The 'BE' Long Wand was the best 'way-back-when' and still is today.

Performance Nozzle for Telescoping Wands

"PUSH" for Soap "Pull" for Pressure

- Quickly attaches to the telescoping wand to increase the chemical application distance by 25 feet & the wash/rinse distance by 40 feet.
- You can apply chemical from 0-65 degrees and rinse from 0-65 degrees without changing the nozzle.
- The 45 degree angle also helps support over 60% of the lance weight when trigger is pulled.



Laser Spray at 0°
Fan Spray up to 65°
with a simple twist!

PART #	DESCRIPTION	PRICE
1347	3.5 Nozzle Size, 4,100 PSI, 190°	\$ 21.92
1365	4.0 Nozzle Size, 4,100 PSI, 190°	\$ 21.92
1424	4.5 Nozzle Size, 4,100 PSI, 190°	\$ 21.92
1440	5.0 Nozzle Size, 4,100 PSI, 190°	\$ 21.92
1466	5.5 Nozzle Size, 4,100 PSI, 190°	\$ 21.92
1470	6.0 Nozzle Size, 4,100 PSI, 190°	\$ 21.92
1590	6.5 Nozzle Size, 4,100 PSI, 190°	\$ 21.92
1594	7.0 Nozzle Size, 4,100 PSI, 190°	\$ 21.92
1623	8.0 Nozzle Size, 4,100 PSI, 190°	\$ 21.92



Replacement Gun



#1815

Industrial Hose Reel

The Industry's Best Hose Reel Value!
They're Rugged!

Solid Steel Construction, Durable Powder Coat,
Direct Hand Crank rewind, Full Flow Swivel Brass
Joint, 5,000 PSI Rated, 3-1 Burst Factor



PART #	DESCRIPTION	NET PRICE
1313	HOLDS 50' of 3/8" 1-wire	\$ 54.95
1314	HOLDS 100' of 3/8" 1-wire	\$ 65.93
1315	HOLDS 150' of 3/8" 1-wire	\$ 76.92
1316	HOLDS 200' of 3/8" 1-wire	\$ 87.91
REPLACEMENT SWIVELS		
1008	SWIVEL, FITS #1313 & 1314	\$ 17.53
1001	SWIVEL, FITS #1315 & 1316	\$ 17.53
REPLACEMENT HANDLE		
1002	REPLACEMENT HANDLE	\$ 5.66

M-Series Compact Mini Hose Reel

- Only 14.5" tall
- Fully adjustable brake
- Heavy duty ABS bearings require no lubrication
- This reel is ideally suited to fit into tight space applications

• 7-10 DAY BUILD TIME

PART #	DESCRIPTION	NET PRICE
1862	MINI REEL - HOLDS 75' 3/8" or 50' 1/2"	\$ 175.20
1857	MINI REEL - HOLDS 150' 3/8" or 100' 1/2"	\$ 197.80



HOSETRACT

M-Series Manual Hose Reel

- Hosetract industrial hose reels offer a durable and simple design.
- Self lubricating ABS bearings.
- Adjustable brake-adjust tension with hand knob.
- Heavy duty brass swivel to reduce corrosion potential.

• 7-10 DAY BUILD TIME



ADD STAINLESS STEEL PLUMBING
to any Hosetract Reel for only
\$78.19 - #3303

Stackable Frame Hose Reel

- Stack capability with no added parts needed
- Self lubricating ABS bearings
- Adjustable brake - adj, tension w/hand knob
- HD - 4,000 PSI swivel for longer service
- Part number represents one reel

• 7-10 DAY BUILD TIME



HOSETRACT

E-Series 12V Electric Hose Reel

- 12 V DC motor driven
 - Self lubricating ABS bearings
 - Motor sprocket & chain pinch points are safe guarded
 - Brass swivel reduces corrosion
- 7-10 Day Build Time, Must ship freight lines

PART #	DESCRIPTION	NET PRICE
1782	12v ELECTRIC - HOLDS 350' 3/8" or 275' 1/2"	\$ 467.03
1783	12v ELECTRIC - HOLDS 450' 3/8" or 375' 1/2"	\$ 494.51
1784	12v ELECTRIC - HOLDS 550' 3/8" or 475' 1/2"	\$ 587.91

PART #	DESCRIPTION	NET PRICE
1861	HOLDS 100' 3/8" or 75' 1/2"	\$ 171.20
1856	HOLDS 250' 3/8" or 175' 1/2"	\$ 183.50
1858	HOLDS 350' 3/8" or 275' 1/2"	\$ 194.50
1859	HOLDS 450' 3/8" or 375' 1/2"	\$ 224.50
1860	HOLDS 550' 3/8" or 475' 1/2"	\$ 239.95
STAINLESS STEEL		
1868	HOLDS 100' 3/8" or 75' 1/2"	\$ 427.35
1864	HOLDS 250' 3/8" or 175' 1/2"	\$ 475.63
1865	HOLDS 350' 3/8" or 275' 1/2"	\$ 485.64
1866	HOLDS 450' 3/8" or 375' 1/2"	\$ 515.07
1867	HOLDS 550' 3/8" or 475' 1/2"	\$ 536.45

PART #	DESCRIPTION	NET PRICE
1948	STACKER, HOLDS 250' 3/8" or 175' 1/2"	\$ 189.95
1949	STACKER, HOLDS 350' 3/8" or 275' 1/2"	\$ 199.95
1950	STACKER, HOLDS 450' 3/8" or 375' 1/2"	\$ 229.95
1951	STACKER, HOLDS 550' 3/8" or 475' 1/2"	\$ 249.95
STAINLESS STEEL		
1952	STACKER, HOLDS 250' 3/8" or 175' 1/2"	\$ 475.63
1953	STACKER, HOLDS 350' 3/8" or 275' 1/2"	\$ 496.18
1954	STACKER, HOLDS 450' 3/8" or 375' 1/2"	\$ 523.96
1955	STACKER, HOLDS 550' 3/8" or 475' 1/2"	\$ 543.48

"Jumper Hose" Machine To Reel



- Connects Equipment to the Reel
- Rated to over 4400 PSI
- One Swivel End and One Fixed End

PART #	DESCRIPTION	PRICE
1172	2' JUMPER HOSE WITH ENDS	\$ 10.93
1173	3' JUMPER HOSE WITH ENDS	\$ 12.03
1174	4' JUMPER HOSE WITH ENDS	\$ 13.13
1175	5' JUMPER HOSE WITH ENDS	\$ 14.23
1176	6' JUMPER HOSE WITH ENDS	\$ 15.33
1177	7' JUMPER HOSE WITH ENDS	\$ 17.53
1178	8' JUMPER HOSE WITH ENDS	\$ 19.73
1179	9' JUMPER HOSE WITH ENDS	\$ 20.82
1180	10' JUMPER HOSE WITH ENDS	\$ 21.92
1181	11' JUMPER HOSE WITH ENDS	\$ 23.02
1182	12' JUMPER HOSE WITH ENDS	\$ 24.12
1183	13' JUMPER HOSE WITH ENDS	\$ 25.22
1184	14' JUMPER HOSE WITH ENDS	\$ 26.32
1185	15' JUMPER HOSE WITH ENDS	\$ 27.42
1186	16' JUMPER HOSE WITH ENDS	\$ 28.52
1187	17' JUMPER HOSE WITH ENDS	\$ 29.62
1188	18' JUMPER HOSE WITH ENDS	\$ 30.60
1189	19' JUMPER HOSE WITH ENDS	\$ 31.81
1190	20' JUMPER HOSE WITH ENDS	\$ 32.91

Re-Usable Hose Ends

Excellent for field repairs and temporary fixes of high pressure hose.



Repairs can be made with two standard wrenches, no special tools are required.

PART #	DESCRIPTION	PRICE
1191	1 WIRE, 3/8", FIXED	\$ 7.50
1192	1 WIRE, 3/8", SWIVEL	\$ 12.99
1193	2 WIRE, 3/8", FIXED	\$ 8.59
1194	2 WIRE, 3/8", SWIVEL	\$ 13.80

SERPENTINE Pressure Wash Hose

- Super tough cover design
- 1 ea. 3/8" MPT swivel end
- 1 ea. 3/8" MPT fixed end
- Temperature to 250°F
- Tough wrapped outer cover
- Strain reliefs on both ends

Length Greater Than 150' Drop Ships From Manufacturer

SERPENTINE Pressure Wash Hose

PART #	DESCRIPTION	PRICE
3,000 PSI - 1/2" BLACK HOSE - ONE WIRE		
1700	HOSE, BLACK, 50'	\$ 74.67
1701	HOSE, BLACK, 100'	\$ 141.70
4,500 PSI - 1/2" BLACK HOSE - TWO WIRE		
1710	HOSE, BLACK, 50'	\$ 84.56
1711	HOSE, BLACK, 100'	\$ 161.68

Sewer Jetting Hose



- 3,000 PSI Thermo-plastic covering
- Maximum flexibility & very lightweight

PART #	DESCRIPTION	PRICE
1/4" Hose with 1/4" MPT x 1/8" MPT		
1318	50' BLACK, 3,000 PSI	\$ 50.49
1319	100' BLACK, 3,000 PSI	\$ 93.35
1320	150' BLACK, 3,000 PSI	\$ 135.11
1321	200' BLACK, 3,000 PSI	\$ 177.97
1322	250' BLACK, 3,000 PSI	\$ 219.73
1323	300' BLACK, 3,000 PSI	\$ 285.66
1/8" Hose with 1/4" MPT x 1/8" MPT		
1324	50' BLACK, 3,000 PSI	\$ 38.41
1325	100' BLACK, 3,000 PSI	\$ 66.98
1326	150' BLACK, 3,000 PSI	\$ 96.65
1327	200' BLACK, 3,000 PSI	\$ 125.22
1328	250' BLACK, 3,000 PSI	\$ 164.78

The Industry's #1 SELLING HOSE
OUR 4,000 & 6,000 WEIGHS LESS
THAN THEIR 3,000 & 4,500 PSI
AND LASTS MUCH LONGER!



SERPENTINE IS NET PRICE

PART #	DESCRIPTION	ALL NET
4,000 PSI - 3/8" BLACK - ONE WIRE		
1708	WRAPPED HOSE, BLACK, 50', 9.5 LBS.	\$ 39.95
1709	WRAPPED HOSE, BLACK, 100', 18 LBS.	\$ 74.95
4,000 PSI - 3/8" NON-MARKING - GREY - ONE WIRE		
1804	WRAPPED HOSE, GREY, 50', 9.5 LBS.	\$ 49.95
1805	WRAPPED HOSE, GREY, 100', 18 LBS.	\$ 91.95
6,000 PSI - 3/8" BLACK - TWO WIRE		
6001	WRAPPED HOSE, BLACK, 50', 15 LBS.	\$ 49.95
6002	WRAPPED HOSE, BLACK, 100', 28 LBS.	\$ 94.95
6003	WRAPPED HOSE, BLACK, 150'	\$ 169.77
6004	WRAPPED HOSE, BLACK, 200'	\$ 227.81
6,000 PSI - 3/8" NON-MARKING - GREY - TWO WIRE		
6101	WRAPPED HOSE, GREY, 50', 15 LBS.	\$ 62.95
6102	WRAPPED HOSE, GREY, 100', 28 LBS.	\$ 119.95
6103	WRAPPED HOSE, GREY, 150'	\$ 183.46
6104	WRAPPED HOSE, GREY, 200'	\$ 238.08

Longer Lengths Available
Call: 1-800-346-4876

Premium LaserJet Nozzles *Best Buy - by far!*

We have found these to be the 'hardest hitting' most precise nozzle in the industry!

Stainless Steel
Available in 1/4" Screw-In or Quick Connect.

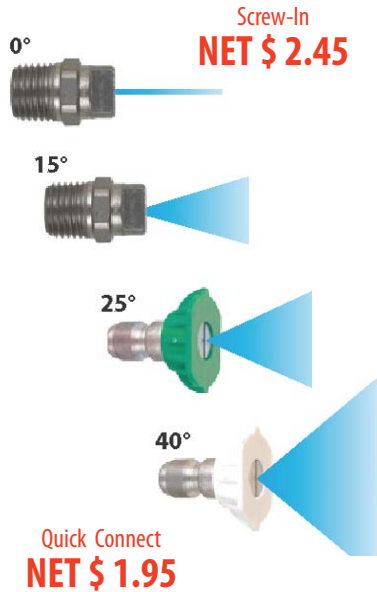

PREMIUM LASERJET NOZZLES - HIGH PRESSURE, SCREW-IN				
NOZZLE SIZE	0°	15°	25°	40°
2.0	LM-0002	LM-1502	LM-2502	LM-4002
2.5	LM-0002.5	LM-1502.5	LM-2502.5	LM-4002.5
3.0	LM-0003	LM-1503	LM-2503	LM-4003
3.5	LM-0003.5	LM-1503.5	LM-2503.5	LM-4003.5
4.0	LM-0004	LM-1504	LM-2504	LM-4004
4.5	LM-0004.5	LM-1504.5	LM-2504.5	LM-4004.5
5.0	LM-0005	LM-1505	LM-2505	LM-4005
5.5	LM-0005.5	LM-1505.5	LM-2505.5	LM-4005.5
6.0	LM-0006	LM-1506	LM-2506	LM-4006
6.5	LM-0006.5	LM-1506.5	LM-2506.5	LM-4006.5
7.0	LM-0007	LM-1507	LM-2507	LM-4007
7.5	LM-0007.5	LM-1507.5	LM-2507.5	LM-4007.5
8.0	LM-0008	LM-1508	LM-2508	LM-4008
8.5	LM-0008.5	LM-1508.5	LM-2508.5	LM-4008.5
9.0	LM-0009	LM-1509	LM-2509	LM-4009
10	LM-0010	LM-1510	LM-2510	LM-4010

PREMIUM LASERJET NOZZLES - HIGH PRESSURE, QUICK CONNECT				
NOZZLE SIZE	0°	15°	25°	40°
2.0	LQ-0002	LQ-1502	LQ-2502	LQ-4002
2.5	LQ-0002.5	LQ-1502.5	LQ-2502.5	LQ-4002.5
3.0	LQ-0003	LQ-1503	LQ-2503	LQ-4003
3.5	LQ-0003.5	LQ-1503.5	LQ-2503.5	LQ-4003.5
4.0	LQ-0004	LQ-1504	LQ-2504	LQ-4004
4.5	LQ-0004.5	LQ-1504.5	LQ-2504.5	LQ-4004.5
5.0	LQ-0005	LQ-1505	LQ-2505	LQ-4005
5.5	LQ-0005.5	LQ-1505.5	LQ-2505.5	LQ-4005.5
6.0	LQ-0006	LQ-1506	LQ-2506	LQ-4006
6.5	LQ-0006.5	LQ-1506.5	LQ-2506.5	LQ-4006.5
7.0	LQ-0007	LQ-1507	LQ-2507	LQ-4007
7.5	LQ-0007.5	LQ-1507.5	LQ-2507.5	LQ-4007.5
8.0	LQ-0008	LQ-1508	LQ-2508	LQ-4008
8.5	LQ-0008.5	LQ-1508.5	LQ-2508.5	LQ-4008.5
9.0	LQ-0009	LQ-1509	LQ-2509	LQ-4009
10	LQ-0010	LQ-1510	LQ-2510	LQ-4010

PLEASE NOTE: If you do not order by part number EnviroSpec has the option to provide you with either 'SHUR-LOC, General Pump or Spraying Systems nozzles. This may result in a 'mix-match' of Vendors when you order multiple nozzles.

0° (Red) 15° (Yellow) 25° (Green) 40° (White)

NOZZLE CHART

NOZZLE SIZE	ORIFICE DIA.	40 PSI	100 PSI	250 PSI	500 PSI	600 PSI	700 PSI	800 PSI	1000 PSI	1200 PSI	1500 PSI	2000 PSI	2500 PSI	3000 PSI	3500 PSI	4000 PSI	5000 PSI
2	.034	0.20	0.32	0.50	0.71	0.77	0.84	0.89	1.00	1.10	1.22	1.41	1.58	1.73	1.87	2.00	2.24
2.5	.039	0.25	0.40	0.63	0.88	0.97	1.05	1.12	1.25	1.37	1.53	1.77	1.98	2.17	2.34	2.50	2.80
3	.043	0.30	0.47	0.75	1.06	1.16	1.25	1.34	1.50	1.64	1.84	2.12	2.37	2.60	2.81	3.00	3.35
3.5	.048	0.35	0.55	0.88	1.24	1.36	1.46	1.57	1.75	1.92	2.14	2.47	2.77	3.03	3.27	3.50	3.91
4	.052	0.40	0.63	1.00	1.41	1.55	1.67	1.79	2.00	2.19	2.45	2.83	3.16	3.46	3.74	4.00	4.47
4.5	.055	0.45	0.71	1.13	1.59	1.74	1.88	2.01	2.25	2.46	2.76	3.18	3.56	3.90	4.21	4.50	5.03
5	.057	0.50	0.79	1.25	1.77	1.94	2.09	2.24	2.50	2.74	3.06	3.54	3.95	4.33	4.68	5.00	5.59
5.5	.060	0.55	0.87	1.38	1.94	2.13	2.30	2.46	2.75	3.01	3.37	3.89	4.35	4.76	5.14	5.50	6.15
6	.062	0.60	0.95	1.50	2.12	2.32	2.51	2.68	3.00	3.29	3.67	4.24	4.74	5.20	5.61	6.00	6.71
6.5	.064	0.65	1.03	1.63	2.30	2.52	2.72	2.91	3.25	3.56	3.98	4.60	5.14	5.63	6.08	6.50	7.27
7	.067	0.70	1.11	1.75	2.47	2.71	2.93	3.13	3.50	3.83	4.29	4.95	5.53	6.06	6.55	7.00	7.83
7.5	.070	0.75	1.19	1.88	2.65	2.90	3.14	3.35	3.75	4.11	4.59	5.30	5.93	6.50	7.02	7.50	8.39
8	.072	0.80	1.26	2.00	2.83	3.10	3.35	3.58	4.00	4.38	4.90	5.66	6.32	6.93	7.48	8.00	8.94
8.5	.074	0.85	1.34	2.13	3.01	3.29	3.56	3.80	4.25	4.66	5.21	6.01	6.72	7.36	7.95	8.50	9.50
9	.076	0.90	1.42	2.25	3.18	3.49	3.76	4.02	4.50	4.93	5.51	6.36	7.12	7.79	8.42	9.00	10.06
9.5	.078	0.95	1.50	2.38	3.36	3.68	3.97	4.25	4.75	5.20	5.82	6.72	7.51	8.23	8.89	9.50	10.62
10	.080	1.00	1.58	2.50	3.54	3.87	4.18	4.47	5.00	5.48	6.12	7.07	7.91	8.66	9.35	10.00	11.18
11	.083	1.10	1.74	2.75	3.89	4.26	4.60	4.92	5.50	6.02	6.74	7.78	8.70	9.53	10.29	11.00	12.30
12	.087	1.20	1.90	3.00	4.24	4.65	5.02	5.37	6.00	6.57	7.35	8.49	9.49	10.39	11.22	12.00	13.42
12.5	.089	1.25	1.98	3.13	4.42	4.84	5.23	5.59	6.25	6.85	7.65	8.84	9.88	10.83	11.69	12.50	13.98
13	.091	1.30	2.06	3.25	4.60	5.03	5.44	5.81	6.50	7.12	7.96	9.19	10.28	11.26	12.16	13.00	14.53
14	.093	1.40	2.21	3.50	4.95	5.42	5.86	6.26	7.00	7.67	8.57	9.90	11.07	12.12	13.10	14.00	15.65
15	.096	1.50	2.37	3.75	5.30	5.81	6.27	6.71	7.50	8.22	9.19	10.61	11.86	12.99	14.03	15.00	16.77
20	.109	2.00	3.16	5.00	7.07	7.75	8.37	8.94	10.00	10.95	12.25	14.14	15.81	17.32	18.71	20.00	22.36
25	.125	2.50	3.95	6.25	8.84	9.68	10.46	11.18	12.50	13.69	15.31	17.68	19.76	21.65	23.39	25.00	27.95
30	.141	3.00	4.74	7.50	10.61	11.62	12.55	13.42	15.00	16.43	18.37	21.12	23.72	25.98	28.06	30.00	33.54
40	.156	4.00	6.32	10.00	14.14	15.49	16.73	17.89	20.00	21.91	24.49	28.28	31.62	34.64	37.42	40.00	44.72
50	.172	5.00	7.91	12.50	17.68	19.36	20.92	22.36	25.00	27.39	30.62	35.36	39.53	43.30	46.77	50.00	55.90
60	.188	6.00	9.49	15.00	21.21	23.24	25.10	26.83	30.00	32.86	36.74	42.43	47.43	51.96	56.12	60.00	67.08

G
P
M

Spraying Systems Nozzles

PLEASE NOTE: If you do not order by part number EnviroSpec has the option to provide you with either 'SHUR-LOC' or Spraying Systems nozzles. This may result in a 'mix-match' of Vendors when you order multiple nozzles.



each \$ 3.79

each \$ 3.79

PLEASE NOTE: If you do not order by part number EnviroSpec has the option to provide you with either 'SHUR-LOC', General Pump or Spraying Systems nozzles. This may result in a 'mix-match' of Vendors when you order multiple nozzles.

SPRAYING SYSTEMS NOZZLES - HIGH PRESSURE, SCREW-IN				
NOZZLE SIZE	0°	15°	25°	40°
2.0	SSN-0002	SSN-1502	SSN-2502	SSN-4002
2.5	SSN-0002.5	SSN-1502.5	SSN-2502.5	SSN-4002.5
3.0	SSN-0003	SSN-1503	SSN-2503	SSN-4003
3.5	SSN-0003.5	SSN-1503.5	SSN-2503.5	SSN-4003.5
4.0	SSN-0004	SSN-1504	SSN-2504	SSN-4004
4.5	SSN-0004.5	SSN-1504.5	SSN-2504.5	SSN-4004.5
5.0	SSN-0005	SSN-1505	SSN-2505	SSN-4005
5.5	SSN-0005.5	SSN-1505.5	SSN-2505.5	SSN-4005.5
6.0	SSN-0006	SSN-1506	SSN-2506	SSN-4006
6.5	SSN-0006.5	SSN-1506.5	SSN-2506.5	SSN-4006.5
7.0	SSN-0007	SSN-1507	SSN-2507	SSN-4007
7.5	SSN-0007.5	SSN-1507.5	SSN-2507.5	SSN-4007.5
8.0	SSN-0008	SSN-1508	SSN-2508	SSN-4008
8.5	SSN-0008.5	SSN-1508.5	SSN-2508.5	SSN-4008.5
9.0	SSN-0009	SSN-1509	SSN-2509	SSN-4009
10	SSN-0010	SSN-1510	SSN-2510	SSN-4010
12	SSN-0012	SSN-1512	SSN-2512	SSN-4012

SPRAYING SYSTEMS NOZZLES - HIGH PRESSURE, QUICK CONNECT				
NOZZLE SIZE	0° (Red)	15° (YELLOW)	25° (GREEN)	40° (WHITE)
2.0	SSNQ-0002	SSNQ-1502	SSNQ-2502	SSNQ-4002
3.0	SSNQ-0003	SSNQ-1503	SSNQ-2503	SSNQ-4003
3.5	SSNQ-0003.5	SSNQ-1503.5	SSNQ-2503.5	SSNQ-4003.5
4.0	SSNQ-0004	SSNQ-1504	SSNQ-2504	SSNQ-4004
4.5	SSNQ-0004.5	SSNQ-1504.5	SSNQ-2504.5	SSNQ-4004.5
5.0	SSNQ-0005	SSNQ-1505	SSNQ-2505	SSNQ-4005
5.5	SSNQ-0005.5	SSNQ-1505.5	SSNQ-2505.5	SSNQ-4005.5
6.0	SSNQ-0006	SSNQ-1506	SSNQ-2506	SSNQ-4006
6.5	SSNQ-0006.5	SSNQ-1506.5	SSNQ-2506.5	SSNQ-4006.5
7.0	SSNQ-0007	SSNQ-1507	SSNQ-2507	SSNQ-4007
7.5	SSNQ-0007.5	SSNQ-1507.5	SSNQ-2507.5	SSNQ-4007.5
8.0	SSNQ-0008	SSNQ-1508	SSNQ-2508	SSNQ-4008
8.5	SSNQ-0008.5	SSNQ-1508.5	SSNQ-2508.5	SSNQ-4008.5
9.0	SSNQ-0009	SSNQ-1509	SSNQ-2509	SSNQ-4009
10	SSNQ-0010	SSNQ-1510	SSNQ-2510	SSNQ-4010
12	SSNQ-0012	SSNQ-1512	SSNQ-2512	SSNQ-4012

These are 1/4" Male Pipe Thread Nozzles
If you require 1/8" nozzles, please change
the part number to read as follows: 'SSN8- ____'

General Pump Nozzles

0° (Red) 15° (Yellow) 25° (Green) 40° (White)

Stainless Steel
Available in 1/4" Screw-In or Quick Connect.

PLEASE NOTE: If you do not order by part number EnviroSpec has the option to provide you with either 'SHUR-LOC' or Spraying Systems nozzles. This may result in a 'mix-match' of Vendors when you order multiple nozzles.

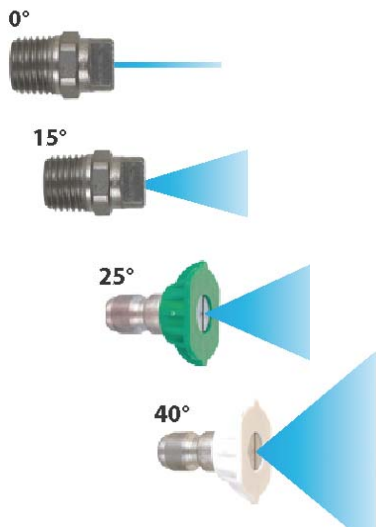

PLEASE NOTE: If you do not order by part number EnviroSpec has the option to provide you with either 'SHUR-LOC', General Pump or Spraying Systems nozzles. This may result in a 'mix-match' of Vendors when you order multiple nozzles.

GENERAL PUMP NOZZLES - HIGH PRESSURE, SCREW-IN				
NOZZLE SIZE	0°	15°	25°	40°
2.0	NOS-0002	NOS-1502	NOS-2502	NOS-4002
2.5	NOS-0002.5	NOS-1502.5	NOS-2502.5	NOS-4002.5
3.0	NOS-0003	NOS-1503	NOS-2503	NOS-4003
3.5	NOS-0003.5	NOS-1503.5	NOS-2503.5	NOS-4003.5
4.0	NOS-0004	NOS-1504	NOS-2504	NOS-4004
4.5	NOS-0004.5	NOS-1504.5	NOS-2504.5	NOS-4004.5
5.0	NOS-0005	NOS-1505	NOS-2505	NOS-4005
5.5	NOS-0005.5	NOS-1505.5	NOS-2505.5	NOS-4005.5
6.0	NOS-0006	NOS-1506	NOS-2506	NOS-4006
6.5	NOS-0006.5	NOS-1506.5	NOS-2506.5	NOS-4006.5
7.0	NOS-0007	NOS-1507	NOS-2507	NOS-4007
7.5	NOS-0007.5	NOS-1507.5	NOS-2507.5	NOS-4007.5
8.0	NOS-0008	NOS-1508	NOS-2508	NOS-4008
8.5	NOS-0008.5	NOS-1508.5	NOS-2508.5	NOS-4008.5
9.0	NOS-0009	NOS-1509	NOS-2509	NOS-4009
10	NOS-0010	NOS-1510	NOS-2510	NOS-4010

GENERAL PUMP NOZZLES - HIGH PRESSURE, QUICK CONNECT				
NOZZLE SIZE	0° (Red)	15° (YELLOW)	25° (GREEN)	40° (WHITE)
2.0	NOQS-0002	NOQS-1502	NOQS-2502	NOQS-4002
2.5	NOQS-0002.5	NOQS-1502.5	NOQS-2502.5	NOQS-4002.5
3.0	NOQS-0003	NOQS-1503	NOQS-2503	NOQS-4003
3.5	NOQS-0003.5	NOQS-1503.5	NOQS-2503.5	NOQS-4003.5
4.0	NOQS-0004	NOQS-1504	NOQS-2504	NOQS-4004
4.5	NOQS-0004.5	NOQS-1504.5	NOQS-2504.5	NOQS-4004.5
5.0	NOQS-0005	NOQS-1505	NOQS-2505	NOQS-4005
5.5	NOQS-0005.5	NOQS-1505.5	NOQS-2505.5	NOQS-4005.5
6.0	NOQS-0006	NOQS-1506	NOQS-2506	NOQS-4006
6.5	NOQS-0006.5	NOQS-1506.5	NOQS-2506.5	NOQS-4006.5
7.0	NOQS-0007	NOQS-1507	NOQS-2507	NOQS-4007
7.5	NOQS-0007.5	NOQS-1507.5	NOQS-2507.5	NOQS-4007.5
8.0	NOQS-0008	NOQS-1508	NOQS-2508	NOQS-4008
8.5	NOQS-0008.5	NOQS-1508.5	NOQS-2508.5	NOQS-4008.5
9.0	NOQS-0009	NOQS-1509	NOQS-2509	NOQS-4009
10	NOQS-0010	NOQS-1510	NOQS-2510	NOQS-4010

These are 1/4" Male Pipe Thread Nozzles
If you require 1/8" nozzles, please change
the part number to read as follows: 'NOS8- ____'

Screw-in or 'QC'
each \$ 3.29

Stainless Steel & Brass Soap Nozzles



PART #	DESCRIPTION	PRICE
NOB-2530	BRASS NOZZLE - Screw-In, 25°, 30	\$ 2.52
NOB-2540	BRASS NOZZLE - Screw-In, 25°, 40	\$ 2.52
NOB-2550	BRASS NOZZLE - Screw-In, 25°, 50	\$ 2.52
NOB-4030	BRASS NOZZLE - Screw-In, 40°, 30	\$ 2.52
NOB-4040	BRASS NOZZLE - Screw-In, 40°, 40	\$ 2.52
NOB-4050	BRASS NOZZLE - Screw-In, 40°, 50	\$ 2.52
NOB-6540	BRASS NOZZLE - Screw-In, 65°, 40	\$ 1.52
SSN-1515	STAINLESS NOZZLE - Screw-In, 15°, 15	\$ 3.79
SSN-1520	STAINLESS NOZZLE - Screw-In, 15°, 20	\$ 3.79
SSN-1525	STAINLESS NOZZLE - Screw-In, 15°, 25	\$ 3.79
SSN-2515	STAINLESS NOZZLE - Screw-In, 25°, 15	\$ 3.79
SSN-2520	STAINLESS NOZZLE - Screw-In, 25°, 20	\$ 3.79
SSN-2525	STAINLESS NOZZLE - Screw-In, 25°, 25	\$ 3.79
SSN-2530	STAINLESS NOZZLE - Screw-In, 25°, 30	\$ 3.79
SSN-2540	STAINLESS NOZZLE - Screw-In, 25°, 40	\$ 3.79
SSN-2550	STAINLESS NOZZLE - Screw-In, 25°, 50	\$ 3.79
SSN-4015	STAINLESS NOZZLE - Screw-In, 40°, 15	\$ 3.79
NOQB-6540	BRASS NOZZLE - Quick Connect, 65°, 40	\$ 1.86

General Hi-Lo Nozzle

"Push" for Soap
"Pull" for Pressure



PSI: 4,100 PSI
TEMP: 195° F

Hi-Lo settings allow for both cleaning and chem applications

PART #	DESCRIPTION	PRICE
1292	3.5 NOZZLE SIZE (BROWN)	\$ 15.33
1293	4.0 NOZZLE SIZE (YELLOW)	\$ 15.33
1294	4.5 NOZZLE SIZE (BLUE)	\$ 15.33
1295	5.0 NOZZLE SIZE (PURPLE)	\$ 15.33
1296	5.5 NOZZLE SIZE (RED)	\$ 15.33
1297	6.0 NOZZLE SIZE (GREEN)	\$ 15.33
1299	7.0 NOZZLE SIZE (ORANGE)	\$ 15.33
1300	8.0 NOZZLE SIZE (GREY)	\$ 15.33

MTM DuraJet Nozzle

"Push" for Soap
"Pull" for Pressure



PSI: 3,000 PSI
TEMP: 300° F

Hi-Lo settings allow for both cleaning and chem applications

PART #	DESCRIPTION	PRICE
1602	DuraJet Push-Pull Nozzle 3.0 White Dot	\$ 7.68
1603	DuraJet Push-Pull Nozzle 3.5 Yellow Dot	\$ 7.68
1604	DuraJet Push-Pull Nozzle 4.5 Orange Dot	\$ 7.68
2050	DuraJet Push-Pull Nozzle 5.0 Red Dot	\$ 7.68
2051	DuraJet Push-Pull Nozzle 5.5 Blue Dot	\$ 7.68
2052	DuraJet Push-Pull Nozzle 6.5 Black Dot	\$ 7.68
2053	DuraJet Push-Pull Nozzle 7.5 Brown Dot	\$ 7.68
2054	DuraJet Push-Pull Nozzle 8.0 Green Dot	\$ 7.68

Dirt Killer Hi-Lo Nozzle



PSI: 4,300 PSI
TEMP: 195° F

"PUSH" for Soap
"PULL" for Pressure

Hi-Lo settings allow for both cleaning and chem applications

PART #	DESCRIPTION	PRICE
1686	VAIRO-JET - RED DOT - NOZZLE SIZE 4.0	\$ 44.95
1687	VAIRO-JET - BLACK DOT - NOZZLE SIZE 4.5	\$ 44.95
1688	VAIRO-JET - BLUE DOT - NOZZLE SIZE 5.5	\$ 44.95

MTM DuraJet Nozzle

Variable Angle Only



PSI: 3,000 PSI
TEMP: 300° F

Adjust From 0° thru 65°

PART #	DESCRIPTION	PRICE
2055	DuraJet Variable Nozzle 3.0 White Dot	\$ 6.54
2056	DuraJet Variable Nozzle 3.5 Yellow Dot	\$ 6.54
2057	DuraJet Variable Nozzle 4.5 Orange Dot	\$ 6.54
2058	DuraJet Variable Nozzle 5.0 Red Dot	\$ 6.54
2059	DuraJet Variable Nozzle 5.5 Blue Dot	\$ 6.54
2060	DuraJet Variable Nozzle 6.5 Black Dot	\$ 6.54
2061	DuraJet Variable Nozzle 7.5 Brown Dot	\$ 6.54
2062	DuraJet Variable Nozzle 8.0 Green Dot	\$ 6.54

Nozzle Clean-Out Tool

Brass or Plastic

Quick Connect to Pressure Washer frame for safe keeping!



PART #	DESCRIPTION	PRICE
1878	NOZZLE CLEAN-OUT TOOL BRASS	\$ 4.38
1879	NOZZLE CLEAN-OUT TOOL PLASTIC	\$ 2.14

Lance Caddy

Slip over the lance and attach lance to the trigger gun!



Holds 7 Nozzles
Stainless Steel, only 0.53 lbs.

PART #	DESCRIPTION	PRICE
1266	LANCE CADDY	\$ 14.23

The Nozzle Keeper

- NEVER lose another nozzle!
- Install your favorite nozzles
- For 3 nozzle set-ups
- Nozzles sold separately



PART #	DESCRIPTION	PRICE
1827	NOZZLE KEEPER, HOLDS 3 NOZZLES	\$ 10.93

Nozzle Holder Twist Type



One of our most popular holders

- 1 ea. 1/4" inlet & 2 ea. 1/4" nozzle outlets
- HP nozzle on one side - LP on the other side
- Twist to change nozzle & draw chem

PART #	DESCRIPTION	PRICE
1275	NOZZLE HOLDER, TWIST TYPE	\$ 22.35
1276	2 EA TEFLON SEATS FOR #1275	\$ 5.44

Premium Rotating Sewer Nozzles

NOT THE CHEAP STUFF

PSI: 3,000 PSI

Rotating 0°
Front Laser Nozzle

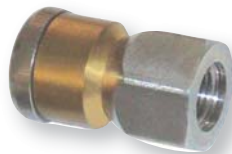

PART #	DESCRIPTION	PRICE
1760	ROTATING NOZZLE, 1/8" FPT, 5-6 GPM	\$ 14.95
1754	ROTATING NOZZLE, 1/4" FPT, 5-6 GPM	\$ 14.95
2282	ROTATING NOZZLE, 1/4" FPT, 8.0 GPM	\$ 44.95

Allison Dual Nozzle Holder - Ball Type

Now Available with Corrosion Proof Ceramic Ball

NOT MADE IN CHINA!

This is the best in the industry!

- GPM: 12 • PSI: 3,500
- Up to 190 degrees
- 1/4" inlet from lance
- 2 ea. 1/4" outlets accommodates 2 nozzles
- Rotate lance to change to soap nozzle

PART #	DESCRIPTION	PRICE
1267	Dual Nozzle Holder with Stainless Steel Ball	\$ 16.43
1268	NOZZLE HOLDER WITH 1127 Swivel	\$ 27.42
1269	Dual Nozzle Holder with Ceramic Ball	\$ 19.73
1270	NOZZLE HOLDER WITH 1127 Swivel	\$ 32.91
1745	CERAMIC BALL, ALUM OXIDE, 13/32	\$ 5.49



Nozzle Boot

Eliminates Scratched Finishes



- Install boot on lance and nozzle in boot
- The rubber bumper protects surfaces from being scratched by the nozzle

PART #	DESCRIPTION	PRICE
1271	NOZZLE BOOT	\$ 2.08

Nozzle Holder Shower Type

GPM: 8
PSI: 3,650 PSI



1/4" inlet from lance
1/4" outlet - accommodates one nozzle.
Twist to reduce pressure to draw chemical.

PART #	DESCRIPTION	NET PRICE
1274	SHOWER NOZZLE HOLDER - ADJUSTABLE	\$ 9.59

Nozzle Caddy for Machine

Bolts to any machine

- No more misplaced nozzles!
- Comes complete with grommets & bolts



PART #	DESCRIPTION	PRICE
1621	COMPLETE HOLDER	\$ 14.23
1622	REPLACEMENT GROMMET	\$.43

SEWER JETTING NOZZLES - Fixed

- 25° front jet & 3 & 4 rear pusher jets
- NPT Threads (not European)
- Rated to 4,000 PSI

PART #	Radial Bullet Nozzles	Price
1758	1/8" NPT / 3-4 GPM	\$ 41.95
1761	1/8" NPT / 5-6 GPM	\$ 41.95
1757	1/8" NPT / 11-14 GPM	\$ 41.95
1752	1/4" NPT / 3-4 GPM	\$ 41.95
1755	1/4" NPT / 5-6 GPM	\$ 41.95
1750	1/4" NPT / 11-14 GPM	\$ 41.95
1765	3/8" NPT / 3-4 GPM	\$ 41.95
1766	3/8" NPT / 5-6 GPM	\$ 41.95



This is not the Cheap 'Dime Store' quality you are accustomed to buying!

- 3 front jets at 12° each
- 6 rear jets at 35° each
- Rated to 4,000 PSI

PART #	Penetrator Nozzles	Price
1759	1/8" NPT / 3-4 GPM	\$ 44.95
1762	1/8" NPT / 5-6 GPM	\$ 44.95
1763	1/8" NPT / 7-10 GPM	\$ 44.95
1753	1/4" NPT / 3-4 GPM	\$ 44.95
1756	1/4" NPT / 7-10 GPM	\$ 44.95
1751	1/4" NPT / 11-14 GPM	\$ 44.95
1767	3/8" NPT / 5-6 GPM	\$ 44.95
1764	3/8" NPT / 11-14 GPM	\$ 44.95

ROTOJET TURBO NOZZLE

#1 Seller in 2003 thru 2008

0° - 25° Nozzle Rotation
Up to 3,000 RPM
High Strength Forged Brass



190° Max Temp
(Shown with optional filter)
Precision ceramic orifice and race
Always start a turbo with nozzle pointed down

Wider pattern for cleaning larger areas such as graffiti removal, concrete floors and side walks, etc.

PART #	PSI	Noz Size	NET Price	Kit #	Kit Price
1548	3600	3.5	\$ 34.95	1570	\$ 29.95
1549	3600	4.0	\$ 34.95	1571	\$ 29.95
1550	3600	4.5	\$ 34.95	1572	\$ 29.95
1551	3600	5.0	\$ 34.95	1573	\$ 29.95
1552	3600	5.5	\$ 34.95	1574	\$ 29.95
1553	3600	6.0	\$ 34.95	1575	\$ 29.95
1562	4500	4.0	\$ 46.95	1584	\$ 39.95
1563	4500	4.5	\$ 46.95	1585	\$ 39.95
1564	4500	5.0	\$ 46.95	1586	\$ 39.95
1565	4500	5.5	\$ 46.95	1587	\$ 39.95
1566	4500	6.0	\$ 46.95	1588	\$ 39.95
1567	4500	7.0	\$ 46.95	1589	\$ 39.95
1554	5800	4.0	\$ 79.95	1576	\$ 41.95
1555	5800	4.5	\$ 79.95	1577	\$ 41.95
1556	5800	5.0	\$ 79.95	1578	\$ 41.95
1557	5800	5.5	\$ 79.95	1579	\$ 41.95
1558	5800	6.0	\$ 79.95	1580	\$ 41.95
1559	5800	7.0	\$ 79.95	1581	\$ 41.95
1560	5800	8.0	\$ 79.95	1582	\$ 41.95
1561	5800	12.0	\$ 79.95	1583	\$ 41.95

TURBO SHIELD

The 'Splatter Shield' attaches to any lance and covers the Turbo Nozzle so harsh chemicals and pressure do not come in contact with delicate surfaces.



PART #	Price
1497	\$43.90

For All Turbos
Quickly attaches to lance

ROTOMAX

0° - 15° Nozzle Rotation
Up to 3,000 RPM
176° Max Temp



Tighter pattern for cleaning concentrated pollutant such as 'chewing gum'

PART #	PSI	GPM	NET Price	Kit #	Price
1498	3500	2.1-2.6	\$ 39.95	1501	\$ 26.95
1499	3500	2.9-4.0	\$ 39.95	Same	--
1500	3500	4.2-6.0	\$ 39.95	Same	--



SUPER ROTOMAX

0° - 15° Nozzle Rotation
Up to 3,000 RPM
176° Max Temp



Tighter pattern for cleaning concentrated pollutant such as 'chewing gum'

PART #	PSI	GPM	Price	Kit #	Price
1502	5800	2.0-4.0	\$ 141.76	1504	\$ 54.89
1503	5800	4.1-7.0	\$ 141.76	Same	--

VIPER TURBO

0° - 15° Nozzle Rotation
Up to 3,000 RPM
190° Max Temp



Tighter pattern for cleaning concentrated pollutant such as 'chewing gum'

PART #	PSI	Noz	Price	Kit #	Price
1505	5000	4.5	\$ 86.76	1506	\$ 49.40
1507	5000	5.5	\$ 86.76	1508	\$ 49.40

High Pressure Filter for Turbos

Manufacturers will not warranty Turbos if they have been used without a filter



#1510 Shown

PART #	PSI	Configuration	NET Price
1509	5000	1/4" MPT x 1/4" FPT	\$ 7.99
1510	5000	1/4" Plug x 1/4" MPT	\$ 7.99

Turbo Nozzles are very aggressive cleaning tools when used carefully. However, they can be dangerous or even deadly.

Exercise extreme caution and wear goggles and protective clothing when using this tool. Keep out of reach of children and away from animals.

Terminator Turbo



Features spring loaded shock absorption for longer ceramic life.

"Quiet-Run" technology with an 18° pattern

PART #	Permissible PSI	Noz Size	Price	Kit #	Price
2002	5000	3.0	\$ 41.91	2003	\$ 38.41
2004	5000	3.5	\$ 41.91	2005	\$ 38.41
2006	5000	4.0	\$ 41.91	2007	\$ 38.41
2008	5000	4.5	\$ 41.91	2009	\$ 38.41
2010	5000	5.0	\$ 41.91	2011	\$ 38.41
2012	5000	5.5	\$ 41.91	2013	\$ 38.41
2014	5000	6.0	\$ 41.91	2015	\$ 38.41
2016	5000	6.5	\$ 41.91	2017	\$ 38.41
2018	5000	7.0	\$ 41.91	2019	\$ 38.41
2020	5000	8.0	\$ 41.91	2021	\$ 38.41

M-16 Thruster Nozzle

PART #	DESCRIPTION	PRICE
1992	THRUSTER WITH 3.5 NOZZLE	\$ 43.90
1993	THRUSTER WITH 4.0 NOZZLE	\$ 43.90
1994	THRUSTER WITH 4.5 NOZZLE	\$ 43.90
1995	THRUSTER WITH 5.0 NOZZLE	\$ 43.90
1996	THRUSTER WITH 5.5 NOZZLE	\$ 43.90
1997	THRUSTER WITH 6.0 NOZZLE	\$ 43.90
1998	THRUSTER WITH 6.5 NOZZLE	\$ 43.90
1999	THRUSTER WITH 7.0 NOZZLE	\$ 43.90
2000	THRUSTER WITH 8.0 NOZZLE	\$ 43.90
1439	REPAIR KIT	\$ 7.64

Reaches 3-4 stories from the safety of the ground!
Want to go even higher than 3 stories?
Simply connect the thruster to a Telescoping Lance!
Then throw up to 6 stories high!

- Push for Fully Adjustable Soap from 0° to 65°
- Pull Back for Adjustable High Pressure from 0° to 65°

Comes Standard with:

- 50' of Chemical Line
- Premium Stainless Filter

M-16 Thruster



Attaches to end of Lance

ALLISON STILETTO TURBO LASER

*cuts like a
RAZOR KNIFE
at much higher
RPM*

THE SHARPEST CUTTING TURBO IN THE INDUSTRY!

Shown with
Optional Filter



THE INDUSTRY'S BEST BUY!

Place the Stiletto Turbo Laser on the end of the lance - pull the trigger and watch the zero degree laser produce a cleaning path of 10 to 60 degrees* while rotating as high as 3,500 rpm.

Absolutely nothing in the industry cleans like the...

STILETTO TURBO LASER!

OPERATING PRESSURE 5,100 PSI

At 2,000 to 3,000 psi - you'll lift chewing gum from sidewalks, barnacles from boats, remove graffiti & paint, remove concrete from truck bodies and new construction, rust from trailer frames, etc.

At 5,000 (+) psi - you can remove paint from auto bodies and chew through plywood and concrete. Yes - there is always a reason to own a...

STILETTO TURBO LASER!

Tighter pattern for cleaning concentrated pollutant such as chewing gun, paint removal, tar, bugs, etc.

PART #	PSI	Noz Size	Price	Kit #	Price
1965	5100	3.0	\$ 49.40	1966	\$ 32.91
1967	5100	3.5	\$ 49.40	1968	\$ 32.91
1969	5100	4.0	\$ 49.40	1970	\$ 32.91
1971	5100	4.5	\$ 49.40	1972	\$ 32.91
1973	5100	5.0	\$ 49.40	1974	\$ 32.91
1975	5100	5.5	\$ 49.40	1976	\$ 32.91
1977	5100	6.0	\$ 49.40	1978	\$ 32.91
1979	5100	6.5	\$ 49.40	1980	\$ 32.91
1981	5100	7.5	\$ 49.40	1982	\$ 32.91
1983	5100	8.0	\$ 49.40	1984	\$ 32.91

The purpose of a Thruster Nozzle
Most chemical injectors will draw around 10% to 12% and oftentimes that is not near enough. The reason for this limited draw is because the more high pressure hose you have on your system the less the injector will draw. Attached at the end of the lance the Thruster will allow you to draw in the 20-40% range.

The THRUSTER attaches to the end of your lance and allows you to stand on the ground and throw chemical as high as 30-45 feet.



Industrial Trigger Jet Spray Guns

for SHURFLO & Other Low Pressure Pumps

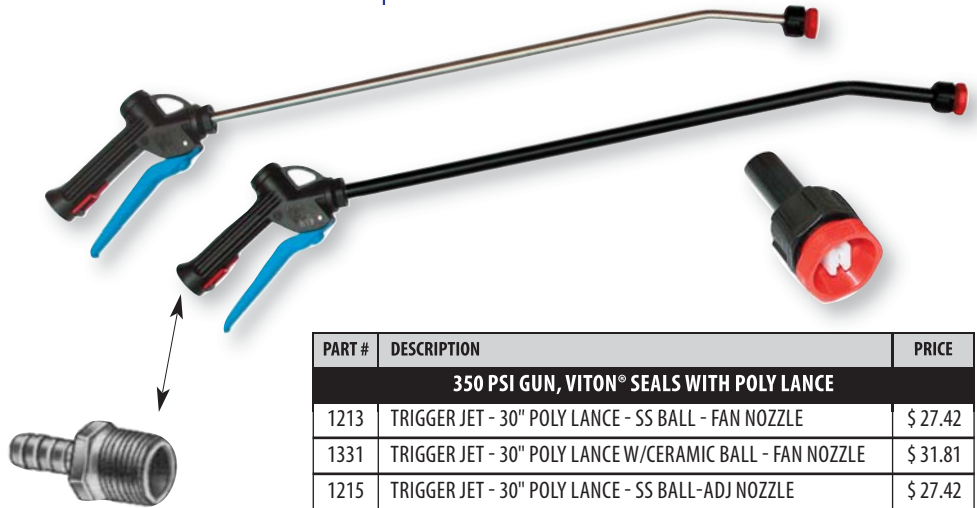

Guns have 1/2" Inlet - so if you are using a...

...1/4" Chem Line order Brass Barb #1726

...3/8" Chem Line order Brass Barb #1727

...1/2" Chem Line order Brass Barb #1728

PART #	DESCRIPTION	PRICE
1726	BRASS BARB	\$ 3.85
1727	BRASS BARB	\$ 3.85
1728	BRASS BARB	\$ 4.12

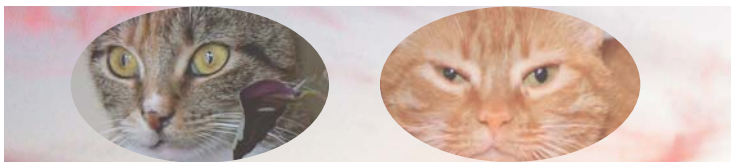

Chemical Tubing

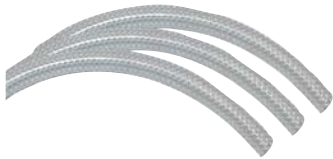

- Clear Reinforced Poly Tubing which is highly resistant to chemicals, fuel & solvents
- Working pressure of 250 PSI with a burst pressure of 750 PSI

PART #	DESCRIPTION	PRICE
1/4" POLYBRAID CHEMICAL TUBING - 250 Working / 750 Burst		
1159	1/4" X 25' ROLL	\$ 7.64
1160	1/4" X 50' ROLL	\$ 14.23
1161	1/4" X 100' ROLL	\$ 27.42
1162	1/4" X 300' ROLL	\$ 65.88
3/8" POLYBRAID CHEMICAL TUBING - 250 Working / 750 Burst		
1163	3/8" X 25' ROLL	\$ 10.93
1164	3/8" X 50' ROLL	\$ 18.63
1165	3/8" X 100' ROLL	\$ 38.41
1166	3/8" X 300' ROLL	\$ 93.35
1/2" POLY BRAID CHEMICAL TUBING - 250 Working / 750 Burst		
2217	1/2" X 100' ROLL - IDEAL FOR ROOF CLEANING	\$ 49.40
2637	1/2" X 300' ROLL - IDEAL FOR ROOF CLEANING	\$ 109.84
3/4" POLYBRAID CHEMICAL TUBING - 250 Working / 750 Burst		
2483	3/4" X 100' ROLL	\$ 76.87
2709	3/4" X 300' ROLL	\$ 186.76
1/4" PREMIUM CLEAR CHEMICAL LINE		
1167	1/4" PREMIUM CHEM LINE, 100'	\$ 38.41
2199	1/4" STANDARD CHEMICAL LINE, 100'	\$ 19.73

PART #	DESCRIPTION	PRICE
350 PSI GUN, VITON® SEALS WITH POLY LANCE		
1213	TRIGGER JET - 30" POLY LANCE - SS BALL - FAN NOZZLE	\$ 27.42
1331	TRIGGER JET - 30" POLY LANCE W/CERAMIC BALL - FAN NOZZLE	\$ 31.81
1215	TRIGGER JET - 30" POLY LANCE - SS BALL-ADJ NOZZLE	\$ 27.42
1332	TRIGGER JET - 30" POLY LANCE W/CERAMIC BALL - ADJ. NOZZLE	\$ 31.81
1216	TRIGGER JET - 53" POLY LANCE - SS BALL - ADJ. NOZZLE	\$ 32.91
1333	TRIGGER JET - 53" POLY LANCE WITH CERAMIC BALL - ADJ NOZZLE	\$ 37.31
350 PSI GUN, VITON® SEALS WITH STAINLESS LANCE		
1214	TRIGGER JET - 30" SS LANCE - SS BALL - FAN NOZZLE	\$ 27.42
1334	TRIGGER JET - 30" SS LANCE W/CERAMIC BALL - FAN NOZZLE	\$ 31.62
750 PSI GUN ONLY		
1212	TRIGGER JET SPRAY GUN- STAINLESS BALL (NO LANCE)	\$ 21.92
1169	TRIGGER JET SPRAY GUN-CERAMIC BALL (NO LANCE)	\$ 25.22

Memory Coil Chemical Line

NON-KINKING



- Strain reliefs on both ends
- Brass 1/4" MPT ends

Shown with Optional Trigger-Jet Gun

PART #	DESCRIPTION	PRICE
4999	30', MEMORY COIL CHEMICAL LINE	\$ 10.99
4998	50', MEMORY COIL CHEMICAL LINE	\$ 21.98

Poly Fittings

For SHURFLO & Low Pressure Pumps

- When you order a ShurFlo pump be sure and ask your sales rep for the correct poly barbs.

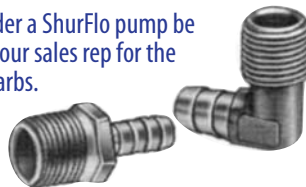

PART #	DESCRIPTION	PRICE
1077	BARB, POLY, 1/4" MPT X 1/4" BARB	\$ 2.14
1078	BARB, POLY, 3/8" MPT x 1/4" BARB	\$ 2.14
1079	BARB, 90°, POLY, 1/4" MPT	\$ 2.14
1080	BARB, 90°, POLY, 3/8" MPT	\$ 2.14

Replacement Cone Sprayer Nozzle



- Solid brass construction
- Fully adjustable
- Fits 1/4" MPT Lance

PART #	DESCRIPTION	PRICE
1211	REPLACEMENT CONE SPRAY NOZZLE	\$ 4.34

SHURFLO Pumps

with Chemical Resistance Seals & Valves

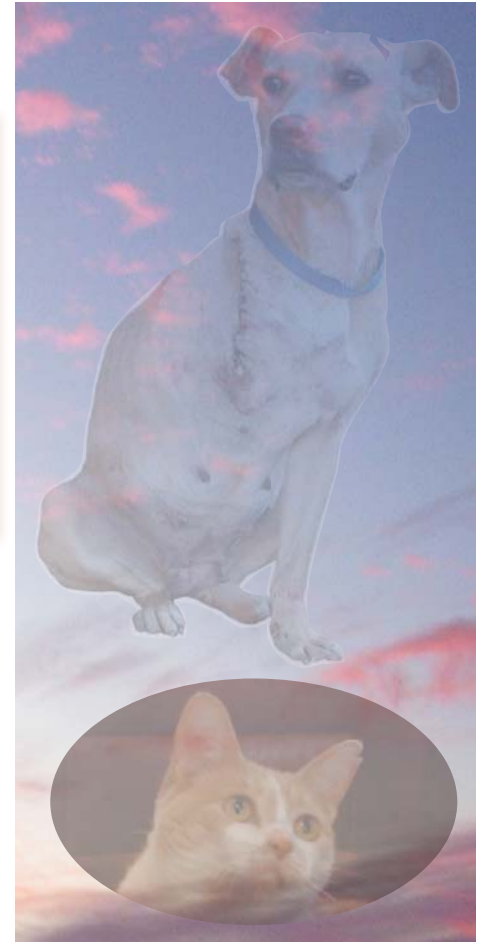

PART #	DESCRIPTION	PRICE
12 VOLT SHURFLO PUMPS WITH PREMIUM VALVES		
1049	1.4 GPM / 60 PSI / VITON VALVES	\$ 76.87
1050	1.8 GPM / 100 PSI / VITON VALVES	\$ 87.86
1671	ALLISON Chem Induction Pump	\$ 99.95
1051	3.0 GPM / 45 PSI / VITON VALVE	\$ 93.35
1052	3.6 GPM / 45 PSI / VITON VALVE	\$ 151.10
115 VOLT SHURFLO PUMPS WITH PREMIUM VALVES		
1053	1.4 GPM / 60 PSI / VITON VALVES	\$ 109.84
1054	1.5 GPM / 150 PSI / VITON VALVES	\$ 142.80
1055	1.6 GPM / 100 PSI / VITON VALVES	\$ 131.81

PART #	DESCRIPTION	PRICE
REPAIR KITS FOR SHURFLO PUMPS		
1046	CHECK VALVE - 8000 SERIES	\$ 16.43
1047	CHECK VALVE - 8020, 8030 SERIES	\$ 16.43
1048	CHECK VALVE - 2088 SERIES	\$ 16.43
1040	BY-PASS, VITON, ALL MODELS	\$ 38.41
1041	DIAPHRAGM KIT, 8000 SERIES	\$ 16.43
1045	DIAPHRAGM DRIVE KIT, 2088 SERIES	\$ 25.22
1042	PRESSURE SWITCH, 8000, 60 PSI, VITON SERIES	\$ 21.92
1043	PRESSURE SWITCH, 8000, 100 PSI, VITON SERIES	\$ 19.73
1044	PRESSURE SWITCH, 2088, 45 PSI, VITON SERIES	\$ 38.41

WASTE WATER RECOVERY SYSTEM



PART #	DESCRIPTION	NET PRICE
9300	20' Boom Only	\$ 878.02
9301	40' Boom Only	\$ 1703.30
9302	101 CFM Vac with Pump-out	\$ 1295.00
9303	202 CFM Vac with Pump-out	\$ 1495.00
9305	Tote Bag	\$ 82.42

PREMIUM BRUSHES



10", 18" & 24"



Premium & Detail

PART #	PREMIUM VEHICLE & HOUSE BRUSH	PRICE
1451	10" Truck Wash	\$ 9.84
1450	10" Premium Truck & House	\$15.33
1454	14" Premium	\$ 18.63
1455	14" Fine Finish	\$ 19.73
1452	18" Truck Wash	\$ 20.82
1453	24" Truck Wash	\$ 21.92
1456	Bi-Level, 10", Hi-Pile Green	\$ 21.92
1457	Bi-Level, 10", Standard Yellow	\$ 18.63
1459	Gutter & Exhaust Stack Brush	\$25.22
1458	Bi-Directional Brush - 1/2 Circle	\$27.42
1445	Rotating Brush	\$ 37.31



1/2" Circle



Bi-Level Brush



Rotating Brush



Gutter/Stack Brush

12-Volt Electric, 4 Gallon Backpack Sprayer



► Convenient battery pack removes in seconds for remote charging.

Sprays 120 Gallons @ 40 PSI on a single charge

Advanced Microprocessor Pump Controller

Variable Speed Pump and adjustable nozzle

Open Tip for long range, high volume spraying

PART #	NOTES:	PRICE
1962	Backpack Sprayer Complete	\$ 213.51
1678	Replacement Battery Pack	\$ 43.90
1679	Spare Wall Charger and Cable	\$ 32.91
1680	Spare Pump, Hose and Hardware	\$ 109.84
1681	Spare PC Board & Wiring Harness	\$ 54.89
1682	Spare Wand Assembly	\$ 19.73



► Computer engineered design perfectly matches the body's contours.

► Heavily padded adjustable shoulder straps, full back pad and waist belt provide the ultimate in user comfort.

Pump-Up Sprayers

1.5 Quart Thumb Sprayer



PART #	DESCRIPTION	PRICE
1822	1.5 QUART THUMB SPRAYER	\$ 6.54
1883	PUMP-UP SPRAYER, 2.0 GAL	\$ 15.33
1844	BACK-PACK SPRAYER	\$ 49.40



2.0 Gallon Pump-Up Sprayer



4.0 Gallon, 90 PSI Backpack Sprayer (includes 4 nozzles)

SPECIALTY ROTATING CLEANING EQUIPMENT

Best Price Anywhere
GUARANTEED!

\$399.95
#1869



MUD-CAT Under Carriage Cleaner



Increase your bottom line for offering more services such as this.

- o Includes 7500 PSI Ball Valve
- o Collapses for easy storage

- o Spins up to 3,000 RPM at 4,000 PSI
- o Has 2 each 0° Nozzles for ripping heavy build-up and 2 each 15° Nozzles that rinse it away

ROOF CLEANER from: **MOSMATIC**

\$895.00
#1863

height (adjustable) from 7.7-9"

Nozzles Not Included

Wheel Width (adjustable) from 21.6"-25.2"

Max Pressure 4000 PSI
Nozzles Not Included

Stainless Steel Housing provide approximately 21" of Cleaning

Weight 31.9 lbs

Super Heavy Duty Sand Blast Kit*

Heavy Duty
PSI: 5,500
GPM: 10
Weight: 9.25 lbs.



*0° Nozzle Required

PART #	DESCRIPTION	PRICE
1288	SAND BLAST KIT W/25' OF HOSE*	\$ 76.87

Commercial Sand Blast Kit

Medium Duty
PSI: 3,500
GPM: 10
Weight: 9.25 lbs.



PART #	DESCRIPTION	PRICE
1287	KIT, W/10' OF HOSE & PROBE	\$ 49.40

Roof & Ice Walkers

High quality, easy to put over boots. These walkers provide fantastic traction. Don't risk a fall, keep these on your truck for use in slippery conditions.



Unique 360° spike pattern provides more push off and lateral grip. The replaceable Ice Diamond™ carbide spikes are integrated into the new open/close split rubber tread for ultimate traction.



PART #	DESCRIPTION	PRICE
1683	GET-A-GRIP WALKERS 4-7 SHOE	\$ 37.85
1684	GET-A-GRIP WALKERS 7-10 SHOE	\$ 37.85
1685	GET-A-GRIP WALKERS 10-14 SHOE	\$ 37.85

Transformers & Igniters



PART #	DESCRIPTION	PRICE
1404	12V IGNITOR ASSY SDC BECKETT	\$104.34
1405	12V IGNITOR ASSY ADC BECKETT	\$104.34
1406	TRANSFORMER FOR 120V 'A' BECKETT Old Style	\$76.87
1407	TRANSFORMER FOR 230V 'A' SERIES BECKETT	\$65.88
1408	TRANSFORMER FOR 230V 'S' SERIES BECKETT	\$71.37
1409	TRANSFORMER FOR 120V 'A' BECKETT SMALL VERSION - See 1406 for old style	\$49.40
1375	IGNITER, WAYNE, 12V, BACK HINGE FOR MSR	\$120.82
1376	TRANSFORMER, WAYNE, 120V SIDE HINGE	\$71.37
1377	TRANSFORMER, WAYNE, 120V, BACK HINGE	\$76.87
1378	TRANSFORMER, WAYNE, 230V, SIDE HINGE	\$98.85

CHEK-MATE Transformer/Igniter Tester



- No more guessing!
- Simply touch the two electrodes and if the light comes on the unit is working properly.

PART #	DESCRIPTION	PRICE
1947	CHECK MATE IGNITION TESTER	\$ 76.88

Fuel Solenoid

- For Beckett and Suntec

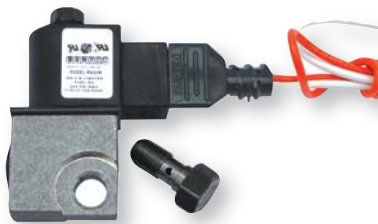

PART #	DESCRIPTION	PRICE
1418	SUNTEC 120 VOLT	\$ 27.42
1392	SUNTEC 220 VOLT	\$ 29.62
1417	SUNTEC 12 VOLT	\$ 36.21

Volt Master 3,000 Watt Generator

- 3,000 watt, 120 volt, 3,600 RPM
- Industrial Double Weld Base
- Direct Replacement for Winco
- Same footprint as Winco
- Built-in Voltmeter
- Re-settable fuse
- Used on Allison Iron Horse Equipment



PART #	DESCRIPTION	PRICE
1438	3000 kW Generator	\$ 475.08

SUNTEC Fuel Pump

- Fits Beckett & Wayne
- Solenoid must be ordered separately

PART #	DESCRIPTION	PRICE
1399	FUEL PUMP, A2VA7116	\$ 43.90
1400	FUEL PUMP, A1VA7112	\$ 98.85
1402	FUEL PUMP, A1VA7912	\$ 98.85



WINCO 2,000 Watt Generator

- 2,000 watt, 120 volt, 3,600 RPM
- Rotates in either direction
- 3 carbon brushes
- Dual sealed permanent bearing



PART #	DESCRIPTION	PRICE
1434	GENERATOR, WINCO, 2000KW	\$ 525.77
1435	BRUSH (2 REQUIRED)	\$ 14.07
1436	RECEPTACLE (2 REQUIRED)	\$ 11.52
1437	RECTIFIER (1 REQUIRED)	\$ 43.90

BECKETT Fuel Pump

With "Built-In" Solenoid

- Replacement for Suntec A2VA-7116
- Includes "built-in" fuel solenoid
- Easy installation

PART #	DESCRIPTION	PRICE
1397	BECKETT FUEL PUMP WITH 115 VOLT SOLENOID	\$ 82.11
1398	BECKETT FUEL PUMP WITH 12 VOLT SOLENOID	\$ 82.11
1396	REPAIR KIT FOR BECKETT SOLENOID, 12 VOLT	\$ 16.43
1395	REPAIR KIT FOR BECKETT 115V SOLENOID	\$ 16.43



Beckett Burners



- Interchanges with Wayne
- Easy installation
- Special burner made to Espec specifications

One of the longest lasting, most trouble free Burners in the Industry!

PART #	DESCRIPTION	PRICE
1390	12Volt ADC - for Washers up to 6 GPM	\$ 507.77
1391	12 Volt SDC - for Washers over 6 GPM	\$ 548.35
1393	115 Volt AFG - for Washers up to 6 GPM	\$ 391.84
1394	115 Volt SF - for Washers over 6 GPM	\$ 417.53

Burner Nozzles

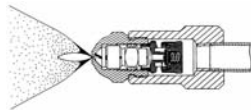

PART #	DESCRIPTION	PRICE
1379	BURNER NOZZLE, 1.00 80B	\$ 4.12
1380	BURNER NOZZLE, 1.25 80B	\$ 4.12
1381	BURNER NOZZLE, 1.50 80B	\$ 4.12
1382	BURNER NOZZLE, 1.75 80B	\$ 4.12
1383	BURNER NOZZLE, 2.00 80B	\$ 4.12
1384	BURNER NOZZLE, 2.25 80B	\$ 4.12
1385	BURNER NOZZLE, 2.50 80B	\$ 4.12
1386	BURNER NOZZLE, 2.75 80B	\$ 4.12
1387	BURNER NOZZLE, 3.00 80B	\$ 4.12

Burner "On/Off" Switch

- On / Off positioning
- Rated to 50 Amps @ 12 Volts



PART #	DESCRIPTION	PRICE
1388	ON/OFF SWITCH	\$ 8.74

Adjustable Thermostats

- Panel Mount
- Adjustable
- Rated to 3,500 PSI
- Super quick response



PART #	DESCRIPTION	NET PRICE
1349	PREMIUM PANEL MOUNT THERMOSTAT	\$ 27.95
1425	STANDARD THERMOSTAT 194 DEGREE	\$ 23.95

Pre-Set Thermostats

Last Longer and More Accurate than typical thermostats

- On and Off at constant temperature
- 5° - 8° deadband - super quick response



PART #	DESCRIPTION	PRICE
1884	PRE-SET THERMOSTAT, SHUTS OFF AT 160°	\$ 27.42
1885	PRE-SET THERMOSTAT, SHUTS OFF AT 190°	\$ 27.42

Adjustable Thermostats

- Mounts on discharge side of heating coil
- Interchanges with all in-line thermostats
- Temp range 60°F to 230°F



PART #	DESCRIPTION	PRICE
1426	IN LINE THERMOSTAT	\$ 54.89

Hi-Limit Safety Burner Shut Down

- Shuts down the fuel solenoid at 210°



PART #	DESCRIPTION	PRICE
1107	HI LIMIT SWITCH WITH LEAD	\$ 18.32

Pressure Switch

- The Industry's Best Pressure Switches
- Rated to 250V, 15 amps & 190°F



PART #	DESCRIPTION	PRICE
1370	PRESSURE SWITCH, 3,650 PSI, 1/4" MPT	\$ 20.82
1371	PRESSURE SWITCH, 3,650 PSI, 3/8" MPT	\$ 20.82
1372	PRESSURE SWITCH, 6,500 PSI, 1/4" MPT	\$ 65.88

Flow Switch

- Tungsten contact reed switch
- Viton seals
- Rated to 4,400 PSI
- For solenoid control only



PART #	DESCRIPTION	PRICE
1367	FLOW SWITCH, VERTICAL	\$ 38.41
1368	FLOW SWITCH, VERTICAL OR HORIZONTAL	\$ 38.41

Industrial Flow Switch

- Both are rated to 5,000



PART #	DESCRIPTION	PRICE
1369	FLOW SWITCH, TMT, 12 GPM	\$ 43.90
2272	PHOENIX, RATED TO 18 GPM	\$ 142.80

Vac Switch

- Installs on the inlet side of the pump
- 1/4" FPT connector
- Heavy duty 16 Amp contact
- 140°F maximum water temperature



PART #	DESCRIPTION	PRICE
1373	VACUUM SWITCH, FOR GAS ENGINES	\$ 18.63
1374	VACUUM SWITCH, FOR ELECTRIC MOTORS	\$ 18.63

Burner Tune-Up Kits

- Beckett kit is electrodes and set gauge only
- Wayne kit includes electrodes, coupling, gauge & fuel line

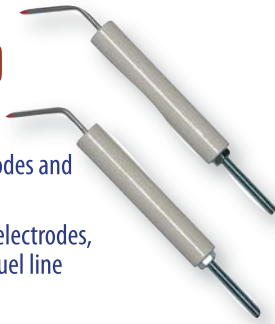

PART #	DESCRIPTION	PRICE
1416	TUNE UP KIT BECKETT	\$ 10.26
1389	WAYNE TUNE-UP KIT	\$ 32.91

RACOR Fuel/ Water Separator

- Water settles to the bottom of the bowl instead of passing to the burner
- When water is visible simply turn the drain valve on the bottom of the bowl to 'dump' the water.



PART #	DESCRIPTION	PRICE
1419	FUEL/WATER SEPARATOR	\$ 37.91
1420	FILTER ELEMENT FOR RACOR	\$ 21.92

Burner Fuel Pump Pressure Gauge

- Fuel pumps run between 100 & 150 PSI
- Comes ready to mount with a 2 1/2" x 1/8" pipe



PART #	DESCRIPTION	PRICE
1128	200 PSI GAUGE TESTER	\$ 8.74

Premium Fuel/ Water Separator

- Water settles to the bottom of the bowl instead of passing to the burner
- When water is visible simply "twist" open the bottom 'dump' valve
- Water is much more visible in this filter than it is with the RACOR & is less expensive!



PART #	DESCRIPTION	PRICE
1794	FUEL/WATER SEPARATOR, REPLACES RACOR	\$ 29.62
1793	FILTER ELEMENT FOR PART #1794	\$ 15.95

Fuel Filter Mounting Block

For All Fuel Filters

- 1/4" FPT inlet and outlet
- Bolts directly to the frame or remotely
- Takes the load off the burner fuel pump



PART #	DESCRIPTION	PRICE
1115	FUEL FILTER MOUNTING BLOCK	\$ 7.64

Electrical Tape

- UL Listed
- 3/4" x 60'
- Professional quality



PART #	DESCRIPTION	PRICE
1601	TAPE, ELECTRICAL	\$ 1.64

NEED A COIL or Coil Replacement Parts

We can match-up any coil you are trying to replace.

- We build them better than original equipment
- Custom Coil Available for those exotic projects we can all come up with.

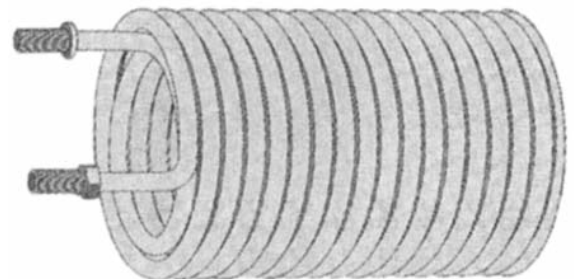

REPLACEMENT DISC FOR COIL END CAPS



PART #	DESCRIPTION	PRICE
1038	18" Donut with hole / Burner End	\$ 38.41
1039	18" Solid Disc / Exhaust End	\$ 27.42

COIL INSULATION BLANKET

- Coil wraps need special insulation
- This is enough to do one coil
- You should always keep a spare wrap on hand because it is doubtful that you will find it locally in case of an emergency

PART #	DESCRIPTION	PRICE
1037	Blanket 1" x 24" x 5'	\$ 28.85

Coil Blow Out Valve

- Install on inlet side of pump
- Use air pressure to blow water out of the system to prevent freezing.



PART #	DESCRIPTION	PRICE
1074	Blow Out Valve	\$ 3.56

Burner Motors

These motors fit both Beckett and Wayne Burners



PART #	DESCRIPTION	PRICE
1410	3450 RPM, 1/7 HP, 115V (2456U)	\$ 71.37
1411	3450 RPM, 1/5 HP, 115V (2900U)	\$ 81.70
1412	3450 RPM, 1/6 HP, 13.5V (21699U)	\$ 87.86
1413	3450 RPM, 1/4 HP, 12V (21539)	\$ 153.79
1414	3450 RPM, 1/4 HP, 115/240V (21344)	\$ 119.86
1415	3450 RPM, 1/4 HP, 240V (2899)	\$ 93.35

12 Volt Burner Relays

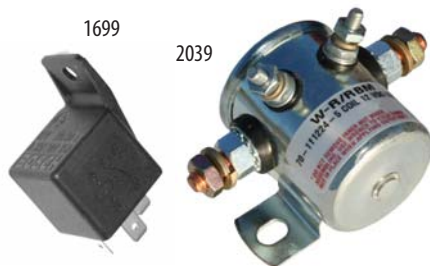

PART #	DESCRIPTION	PRICE
2039	Handles 80 Continuous AMPS	\$ 38.41
1699	Handles 40 Continuous AMPS (compact)	\$21.92

Most 12 Volt Burner failures come as a result of the tremendous spiking that occurs when the burner cycles between on and off.

These burner relays come with easy to install instructions and act as a "shock absorber" as this erratic electricity passes from the battery to the burner. The installation of either of these relays virtually eliminates 12V burner problems.

Each relay comes with an Allison burner wiring diagram.



Beckett & Wayne Burner Parts

PART #	DESCRIPTION	PRICE
1350	Burner to Coil Gasket	\$ 2.53
1217	Blower Wheel, Beckett SF - SM 5-3/4D x 3-7/16W	\$ 14.23
1312	Blower Wheel, Beckett AFG 5-3/4D x 3-7/16W	\$ 15.97
1197	Blower Wheel, Beckett ADC 5-3/4D x 3-7/16W	\$ 12.81
1261	Blower Wheel, Beckett SR 6-1/4D x 3-7/16W	\$ 20.99
1199	Blower Wheel, Beckett SDC 5-3/4D x 3-7/16W	\$ 19.73
1170	Blower Wheel, Wayne 5-3/16 x 3-7/16	\$ 15.82
1201	Blower Wheel, Wayne 6-1/4 x 4-3/16	\$ 16.43
1171	Blower Wheel, Wayne 4-1/4 x 3-1/8	\$ 15.43
1277	Blower Wheel to Pump Coupling Beckett SM - SF	\$ 4.67
1278	Blower Wheel to Pump Coupling Beckett AFG	\$ 4.67
1198	Blower Wheel to Pump Coupling Beckett ADC	\$ 7.64
1200	Blower Wheel to Pump Coupling Beckett SDC	\$ 7.64

Burner Switches & Breakers

Set-up your own Burner Diagnostic Center with these MOMENTARY SWITCHES

It will tell you in 2 seconds what it would normally take 1-2 hours to figure out. A very simple wiring job using the enclosed instructions will have you up and running with a complete burner diagnostic center on your machine in 'no time flat.'



all switches are lettered

PART #	DESCRIPTION	PRICE
1985	On/Off (Lighted Switch)	\$ 17.53
1986	Flow/Pressure Switch	\$ 17.53
1987	Thermostat (mom)	\$ 17.53
1988	Hi-Limit (mom)	\$ 17.53
1989	Engine Terminator (on/off)	\$ 17.53
1813	3 Gang Box (3 switch holder)	\$ 10.93
1812	1 Gang Box (1 switch holder)	\$ 7.64
1741	10 AMP Circuit Breaker	\$ 5.44
1742	15 AMP Circuit Breaker	\$ 5.44
1743	30 AMP Circuit Breaker	\$ 5.44
4000	Build your own Diagnostic Center Control Box Includes Wiring Diagram (Shown as completed unit)	\$ 78.00

Oil Drain Plug



- For engines, pumps & gear boxes
- No more "messy" oil changes
- Simple to install easy to use
- Will not fit Honda

PART #	PRICE
1428	\$ 8.74

Tiny-Tach Hour Meter



Super Easy Installation!

- Takes the "guess work" out of pressure washer problems
- #1429 works on all 1 & 2 cylinder Gas engines including Kohler.
- #3407 is for Diesel engines regardless of cylinders up to 10,000 RPM. It has a solid state, quartz crystal control.

PART #	PRICE	Price
1429	For Gas Engines	\$ 40.32
3407	For Diesel Engines	\$ 149.50

Key-Way Stock Premium

- 1/4" key stock for engine shafts
- 12" length

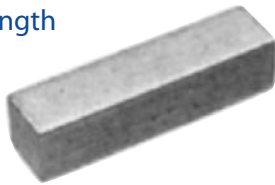

PART #	PRICE
1826	\$ 2.75

• Cut to fill-up the entire shaft

Kohler Engine Filters



PART #	Description	PRICE
1837	Long oil filter / Pro Series	\$ 8.74
1838	Short oil filter / Pro Series	\$ 8.74
1839	Fuel filter	\$ 5.44
1840	Air filter/Pre-Cleaner fits CH-25 & CH-27	\$ 9.54
1841	Pre-cleaner fits CH-25 & CH-27	\$ 4.95
1842	Air filter/Pre-Cleaner,CH-18, CH-20, CH-22	\$ 9.54
1843	Pre-cleaner fits CH-18, 20 & 22	\$ 4.95
3932	Donalson Air Filter for Our 28 WC, 30 & 38	\$ 16.46
3933	Donalson Safety Filter for 3932 above	\$ 19.88

Honda & Briggs Filters



PART #	Description	PRICE
1613	Honda Air Filter for GC160	\$ 6.54
1614	Honda Air Filter for GX160 & GX 200	\$ 4.71
1615	Honda Air Filter for GX240 & GX270	\$ 6.14
1616	Honda Air filter for GX340 & GX390	\$ 6.58
1733	Vanguard Pre-cleaner	\$ 3.62
1734	Vanguard Oil Filter	\$ 12.43
1735	Vanguard Air Filter	\$ 14.23

PART #	Description	PRICE
1617	Honda Oil Filter for GX620 or GX670	\$ 9.67
1618	Honda Spark Plug for GC&GX4HP to 13 HP	\$ 1.37
1619	Honda Dip Stick for GS260 & GX390	\$ 9.84
1620	Honda Dip Stick for GC135 & GX200	\$ 13.13

Throttle Cable Fits All Engines



- For precise engine speed control
- Auto Pre-sets
- Push Pull or 'Snap' Pull and lock
- Designed for harsh, moist environments

PART #	PRICE
1991	\$ 39.88

GAS ENGINES



13 Honda



13 ZongShen Industrial

NET
NET

MUFFLERS INCLUDED
ELECTRIC START

Wow!
\$899.95
18 HP VANGUARD
20 AMP

Wow!
\$965.00
18 HP KOHLER
20 AMP



18 Briggs Vanguard



30 HP Kohler



28 HP Kohler Water Cooled

PART #	Description	PRICE
1770	Kohler, 4 HP, 3/4" Shaft, w/Muf.	\$ 378.27
1771	Kohler, 6 HP, 3/4" Shaft, w/Muf.	\$ 319.77
2067	ZongShen, 6.5 HP, 3/4" Shaft, Industrial, w/Muf.	\$ 228.68
1772	Kohler, 8.5 HP, 1" Shaft, w/Muf.	\$ 668.56
1769	Kohler, 12.75 HP, 1" Shaft, w/Muf.	\$ 695.00
2068	Honda, 13 HP, 1" Shaft, w/Muf.	\$ 574.00
1073	Zong Shen, 13 HP, Industrial, w/Muf.	\$ 291.66
1829	Kohler, 18 HP, 20 Amp Recharge, 1" Shaft - w/Muf.	\$ 965.00
1732	Vanguard, 18 HP, 20 Amp Recharge, 1" Shaft w/Muf.	\$ 899.00
1830	Kohler, 22 HP, 25 Amp Recharge, 1" Shaft	\$ 1554.46
2069	Honda, 20 HP, 18 Amp Recharge, 1" Shaft	\$ 1400.00
1816	Honda, 24 HP, 18 Amp Recharge, 1-1/8" Shaft	\$ 1583.40
1831	Kohler, 25 HP, 25 Amp Recharge, 1" Shaft	\$ 1700.31
1832	Kohler, 27 HP, 25 Amp Recharge, 1-1/8" Shaft	\$ 1972.56
2888	Kohler, 28 HP, Water Cooled, 25 Amp, 1-1/8" Shaft Includes Control Module, Use Muffler #2340	\$ 2101.64
1833	Kohler, 28 HP, EFI Fuel Miser, 25 Amp, 1-1/8" Shaft	\$ 2396.10
1834	Kohler, 30 HP, 25 Amp Recharge, 1-1/8" Shaft	\$ 2026.08
1835	Kohler, 38 HP, 25 Amp Recharge, 1-7/16" Shaft	\$ 2818.05
1836	Kohler, 40 HP, 25 Amp Recharge, 1-7/16" Shaft	\$ 2847.42
KUB35	Kubota, 35 HP Diesel w/Shaft and Controls	\$ 4495.00
KUB65	Kubota, 65 HP Diesel w/Shaft and Controls	\$ 6495.00
MUFFLERS		
1279	Kohler, 18-22 HP, Top Mount, Oil Filter Side	\$ 87.86
1280	Kohler, 18-22 HP, Top Mount, Starter Side	\$ 87.86
1282	Kohler, 18-22 HP, Low Mount, Oil Filter Side	\$ 120.82
1281	Kohler, 18-22 HP, Low Mount, Starter Side	\$ 109.84
1283	Kohler, 25-30 HP, Top Mount, Oil Filter Side	\$ 98.85
1284	Kohler, 25-30 HP, Top Mount, Starter Side	\$ 98.85
1286	Kohler, 25-27 HP, Low Mount Oil Filter Side	\$ 224.93
1285	Kohler, 25-27 HP, Low Mount Starter Side	\$ 224.93
2340	Kohler, 28 Water Cooled, Oil Filter Side	\$ 104.34
3410	HONDA MUFFLER, 20 HP, TOP, STARTER SIDE	\$ 168.13
3411	HONDA MUFFLER, 24 HP, TOP, OIL FILTER SIDE	\$ 168.13
3412	HONDA MUFFLER, 24 HP, TOP, STARTER SIDE	\$ 168.13
3413	HONDA MUFFLER, 20 HP, TOP, OIL FILTER SIDE	\$ 168.13

DIESEL ENGINES



We Carry the Complete Line of:
**KUBOTA, LOMBARDINI & KOHLER
DIESEL ENGINES**

Each engine is specifically matched to your individual requirements.
Please Contact an EnviroSpec Sales Technician for assistance.

ALLISON PREMIUM BELT DRIVE CART

REPLACEMENT CART FOR ANY 13 to 18 HP BELT DRIVE SYSTEM

- Aircraft Aluminum
- Pre-drilled for most engines
- This is, without question, the finest replacement cart in the industry.



Got a good engine?
Got a good pump?
Need a great cart?
Look no further!

Also Available - Nitro Frames, Dual Pumper Frames and many more options. Call for details.

PART #	NET PRICE
9900	\$ 199.95

BASE PLATE shown with 13 HP Honda Engine



- Handles engines up to 30 HP
- Pre-drilled for most engines
- Rubber feet provides shock absorption between unit and bed of truck/trailer.

PART #	PRICE
1899	\$ 38.41

Replacement Cart Parts



Axle Caps

Round Foot



Molded Foot

Replacement Direct Drive Cart

Is it time to replace that worn out cart?

- Rugged Construction
- Powder Coated Frame
- Handles up to 13 HP
- Nozzle Holders/Grommets
- 10" pneumatic tires



PART #	NET PRICE
2049	\$ 89.95

PART #	NOTES:	PRICE
1778	10" Foam filled, never flat tire / wheel	\$ 14.23
1773	13" Pneumatic Tire / wheel for 3/4" Axle	\$ 14.23
1779	13" Foam filled, never flat tire / wheel	\$ 21.92
2330	13" Premium Mag never flat tire/wheel	\$ 38.41
1774	Axle Cap, nickel, fits 5/8" axle	\$ 2.69
1775	Axle Cap, nickel, fits 3/4" axle	\$ 2.62
1776	Rubber Foot, round	\$ 2.14
1777	Molded Rubber Foot	\$ 4.44

Universal Key Switch

- Fits all Engines
- ON/OFF/Start
- Springs back to "ON"
- Panel Mounts
- Two Keys included



PART #	PRICE
1430	\$ 27.42

ALLISON ENGINE TERMINATOR



PART #	PRICE
1990	\$ 32.91

FOR "DC" CURRENT ONLY
DO NOT INSTALL ON AC CURRENT

- Shuts engine down before the pump head overheats & destroys the packings.
- Hooks to the pump inlet and senses incoming "by-pass" water temperature. If the water reaches 145°F the Terminator "kills" the engine.
- Keep in mind if you leave the trigger gun in the "off" position for more than 3 minutes chances are the pump head has already reached 145°F

DUAL BATTERY SELECTOR



- 12 volt burners really "suck down" the juice so you will always need 2 batteries
- For 12VDC pressure systems
- Allows you to run from 1 or both batteries

MARINE DUTY CYCLE

PART #	PRICE
1168	\$ 32.91

Replacement Gas Cap



- Replacement metal gas cap
- Fits all Honda GX series engines

PART #	PRICE
1129	\$ 10.04

Premium Battery Terminal



- Works on all battery cables
- Heavy duty lead construction

PART #	PRICE
1825	\$ 1.64

- Keep lubed with lithium grease

ENGINE THROTTLE DOWN - SAVES PUMPS

- Idles the engine down when you release the trigger.
- Returns to full throttle when the trigger is pulled.
- Not recommended for hot water machines equipped with a generator.

PART #	PRICE
1665	\$ 60.63



Marine Battery Box



- High density plastic
- Tie-down hardware included

PART #	PRICE
1690	\$ 14.23

- Marine grade

Industrial Fuel Line



- 1/4" Thick Wall
- Priced per foot
- For Gas or Diesel

PART #	PRICE
1196	\$ 1.09

Universal Starter Solenoid



- For gas engines
- 5/16: double terminal

PART #	PRICE
1427	\$ 17.56

- Same as used on Vanguards

Oil Caps



Pumps 2SF, 4SF, 2DX

PART #	DESCRIPTION	PRICE
1881	OIL CAP, CAT, PUMPS 2SF, 4SF, 2DX	\$ 10.93



Pumps 5DX, 66DX, 5CP

PART #	DESCRIPTION	PRICE
1880	OIL CAP, CAT, PUMPS 5DX, 66DX, 5CP	\$ 10.93



Most General Pumps

PART #	DESCRIPTION	PRICE
1882	OIL DIP STICK, GENERAL PUMPS	\$ 10.93

Gauge Port Valve Cap

- Mount the gauge on the pump



PART #	DESCRIPTION	PRICE
1060	For EZ General Pumps	\$19.73
1061	For TS2021, TS1511, all T & TS General Pumps	\$19.73

Pump Oil

Ideal for high pressure pumps. Non detergent and non foaming. Specially formulated and rated for superior rust protection and oxidation protection. Not for use in engine.



PART #	DESCRIPTION	PRICE
1064	GENERAL PUMP OIL, 6 PACK / 16 OZ. BOTTLES	\$ 28.54
1065	GENERAL PUMP OIL, 24 PACK / 16 OZ. BOTTLES	\$ 109.84
1066	PUMP OIL, BE PREMIUM, 1 LITER BOTTLE	\$ 6.54
4788	CAT CRANKCASE OIL - 21 OZ. BOTTLE	\$ 8.75



Note: Change oil after the first 50 hours of operation, then every 3 months or as needed. Fill oil half-way on the indicator site glass only. **Do not overfill.**

Replacement Site Glass



Do not over fill your pump.

Fill Oil Half Way
Use only recommended pump oil.

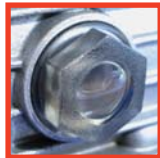

Please remember...

...your pump will arrive to you with a 'shipping plug' where the 'dip stick' is supposed to go. The reason is obvious - right? DO NOT run the pump with the shipping plug. Install the 'dip stick' first.

PART #	DESCRIPTION	PRICE
1689	OIL LEVEL INDICATOR, 3/4" - For the following General Pumps T & TS Series 47 (which includes TS2021), T991 Series, TT & TP Series	\$ 14.23
1421	TSF Series General Pumps	\$ 14.23

Tape - Teflon/Electrical

- Professional quality
- Sells for \$2.00 over elsewhere



PART #	DESCRIPTION	PRICE
1651	TAPE, TEFLON 520' 1/2"	\$.67
1601	TAPE, ELECTRICAL, 3/4" X 60', UL	\$ 1.64

Thread Locker



- Seal and Locks Fittings & Plumbing
- The Name Brand goes for \$139.99

PART #	DESCRIPTION	PRICE
1057	THREAD LOCKER, MEDIUM	\$ 49.40
1058	THREAD LOCKER, HIGH STRENGTH	\$ 49.40

Pump Anti-Freeze Solution

Protect your pump from freezing over the winter. Attaches to any pump inlet to fill pump chamber with anti-freeze solution.



Twist on and depress button.

PART #	DESCRIPTION	PRICE
1768	ANTI-FREEZE SOLUTION	\$ 10.93



Packing Extraction Kit



includes Slide Hammer that attaches to extractor socket and extractor sockets that fit: 5mm, 18mm, 20mm (ex. TS2021), 22mm & 24mm.

PART #	DESCRIPTION	PRICE
1007	PACKING EXTRACTION KIT	\$ 59.97

Packing Insertion Kit

For All General Pumps

Getting the packing out is one thing...
... getting them back in is another



PART #	DESCRIPTION	PRICE
1063	GENERAL PUMP INSERTION KIT	\$ 27.42

Sewer Jetting Valves for General Pumps

- Increase your service by turning your General Pump into a sewer jetting machine.
- Simply remove the center high pressure valve cap & check valve and install the jetter valve in it's place.
- Then when you want a jetter turn the knob and the jetter hose will start pulling itself along.

Call for other brands.



PART #	DESCRIPTION	PRICE
1004	For TT Series General Pumps	\$ 53.54
1005	For EZ Series General Pumps	\$ 54.69
1006	For T & TS General Pumps	\$ 55.90
3340	For TSF Series General Pumps	\$ 87.86

Gear Boxes

- Fits 1450 RPM Pumps with 24MM Pump Shaft & reduces pump speed to 1450 RPM when installed on a 3600 RPM Engine.



PART #	DESCRIPTION For Pumps that have a 24MM Shaft	PRICE
1028	Dual Bearing Heavy Duty Gear Box 1" Eng Shaft - Mfg. PA Use on Engines up to 30 HP	\$ 247.25
1029	Dual Bearing Heavy Duty Gear Box 1-1/8" Shaft - Mfg. PA Use on Engines up to 30 HP	\$ 247.25
1035	General Pump Gear Box - 1" Engine Shaft - Mfg. General/InterPump Use on Engines up to 20 HP	\$ 296.70
1036	General Pump Gear Box - 1-1/8" Engine Shaft - Mfg. General/InterPump Use on Engines up to 20 HP	\$ 296.70

Pump Pulleys and Bushings



To help you select the right pulley and bushing here are a few combinations that we recommend.

115 Volt with Generator

- 1450 RPM Pump Pulley = 8.40
- Pump Pulley Bushing* = 24mm
- Engine Pulley for 1450 = 3.40
- Engine Pulley Bushing** = 1"
- Generator Pulley 1450 = 3.40 - 5/8"

12 Volt with a...

- 1450 RPM Pump Pulley = 8.40
- 1750 RPM Pump Pulley = 7.40
- Pump Pulley Bushing* = 24mm
- Engine Pulley for 1450 = 3.40
- Engine Pulley for 1750 = 3.60
- Engine Pulley Bushing** = 1"

*assuming the pump has a 24mm shaft
*assuming the engine has a 1" shaft

PART #	PULLEY SIZE	PRICE
1654	3.00 - 2-Groove "B" (bushing required)	\$38.41
1655	3.20 - 2-Groove "B" (bushing required)	\$38.41
1656	3.40 - 2-Groove "B" (bushing required)	\$38.41
1658	3.60 - 2-Groove "B" (bushing required)	\$38.41
1659	3.90 - 2-Groove "B" (bushing required)	\$38.41
1661	6.40 - 2-Groove "B" (bushing required)	\$47.20
1662	7.40 - 2-Groove "B" (bushing required)	\$48.30
1663	8.40 - 2-Groove "B" (bushing required)	\$54.89

Typical Generator Pulleys

1657	3.40 - 1-Groove "B" - no bushing required*	\$18.63
1660	3.90 - 1-Groove "B" - no bushing required*	\$27.42

* based on using a generator with a 5/8" shaft

Required Bushings

1025	5/8" For Engine	\$8.78
1026	1" For Engine	\$8.78
1027	1-1/8 For Engine	\$8.78
1032	20mm For Pump	\$8.78
1033	24mm For Pump	\$8.78
1034	32mm For Pump	\$8.78

The Industry's Best Pumps

Please remember...
 ...your pump will arrive to you with a
 'shipping plug'
 where the 'dip stick' goes.

The reason is obvious - right? DO
 NOT run the pump with the
 'shipping plug'.

Install the 'dip stick' first.

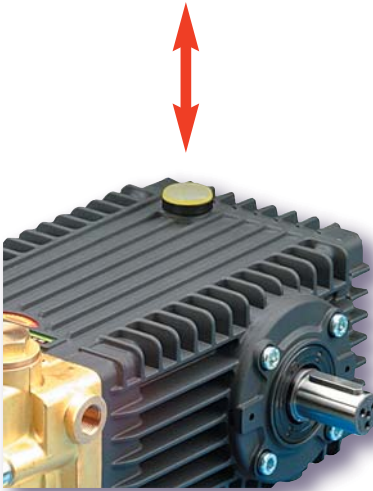

READ THIS FIRST!!

Before you order the wrong pump...

...just remember that all pumps come standard with a RIGHT hand shaft as shown in both pictures above. When you order a pump it is your responsibility to tell us what side the shaft is on. For example: A TS2021 Pump is a right hand shaft as shown in the picture. If you need a left hand shaft you would order a **TS2021-L**.

If you do not put the "L" at the end of the part number we assume you want a Standard Shafted Pump.

Remember - so long as it fits you can always use a Larger Pump on an Engine by simply adjusting the pressure. For example: The A-R XWM2128 is rated at 4100 PSI at 5.5 GPM and requires a 20 HP engine to achieve those specs. However, by adjusting the pressure to 3,500 PSI you can use that same pump on a 18 HP engine or to 2600 PSI and use it on a 13 HP engine.

Extra Heavy Duty Rail Kit

FOR PUMPS USED WITH GAS ENGINES

- Remember, tall rails for gas engine machines and short rails are for electric motor machines.
- These rails fit all pumps commonly found in the pressure washer industry.



PART #	DESCRIPTION	PRICE
1653	TALL RAIL KIT 2 5/8"	\$ 24.59



At Last...

...a pump has been built for the

PROFESSIONAL

who works their equipment over 8 hours a day.



Muscle Pumps built specifically for Gas/Diesel Engine Equipment

IRON HORSE INDUSTRIAL PUMPS

warrants each pump to be free of defects in material or workmanship for a period of 10 years from the date of purchase. In addition, Iron Horse Pumps provides to the original purchaser a Lifetime Pump Head/Manifold Warranty against freeze damage.

WHY IRON HORSE OVER THE REST?

Here are just a few good reasons!

- Oversized & Balanced Connecting Rods
- Blueprinted & Balanced Crankshaft
- Resistance Matched Tapered Roller Bearings
- Premium Polished Ceramic Pistons
- Polished Stainless Steel Check Valves
- Massive Forged Brass Manifold

P/N	SPECIFICATIONS	RPM	NET PRICE	Seal Kit	Valve Kit
H5640	5.6 GPM @ 3500 PSI	1450	\$480.00	HSK08	HVK01
H5655	5.6 GPM @ 5500 PSI	1750	\$875.00	HSK09	HVK41
H8042	8.0 GPM @ 4000 PSI	1750	\$875.00	HSK11	HVK03
H1035	10.0 GPM @ 3500 PSI	1750	\$900.00	HSK12	HVK03
H1327	12.5 GPM @ 3000 PSI	1750	\$900.00	HSK12	HVK03

We carry the complete line of the industry's MOST POPULAR PUMPS

If you don't see what you need just call a Pump Professional at 1-800-346-4876.

NOTE: →

When ordering a 4 GPM Pump we recommend that instead of ordering 4 GPM at 3500 PSI that you order a 4.5 at 3000 PSI. Why? There is no advantage for having the extra 500 PSI. If it won't come off at 3000 there is little chance that it will come off at 3500. But since rinsing represents about 60% of the total wash time - that extra volume will increase you speed substantially.



The Most Popular Pumps typically found on 13 HP Pressure Washers

GENERAL PUMPS Direct Drive

- Bolts Directly to 1" Shafted Gas Engine
- Pump turns at 3400 RPM Engine Speed
- Easy On/Off Installation
- Simply Remove and Replace 4 Bolts

MODEL	SPECIFICATIONS	NET PRICE
EZ3040G	3,000 PSI @ 4.0 GPM	\$ 300.00
EZ4040G	4,000 PSI @ 4.0 GPM	\$ 279.00



A-R PUMPS Direct Drive

- **HD INDUSTRIAL PUMPS**
- Bolts Directly to 1" Shafted Gas Engine
- Pump turns at 3400 RPM Engine Speed
- Easy On/Off Installation
- Simply Remove and Replace 4 Bolts

MODEL	SPECIFICATIONS	NET PRICE
RKV45G40	4,000 PSI @ 4.5 GPM	\$ 316.66
RKV55G40	4,000 PSI @ 5.5 GPM	\$ 319.66

The Most Popular Pumps typically found on Pressure Washers over 13 HP

GENERAL PUMPS Belt or Gear Drive

- These Pumps are either Belt or Gear Box Driven
- Maximum Pump Speed is 1450 RPM
- Easily interchanges with any pump
- Aluminum Connecting Rods

MODEL	SPECIFICATIONS	NET PRICE
TS1511	3,500 PSI @ 4.0 GPM	\$ 368.00
TS2021B	Same as TS-2021 except brass manifold	\$ 365.00
TS2021	3,500 PSI @ 5.6 GPM plated manifold	\$ 448.00
TSF2019	3,600 PSI @ 6.3 GPM	\$ 695.00
TSF2021	3,600 PSI @ 7.0 GPM	\$ 695.00
TSF2219	3,000 PSI @ 7.7 GPM	\$ 780.00
TSF2221	3,000 PSI @ 8.5 GPM	\$ 667.00
TSF2421	2,500 PSI @ 12 GPM	\$ 716.00
TSP1821	5,100 PSI @ 5.5 GPM	\$ 695.00



A-R PUMPS Belt or Gear Drive

- **HD INDUSTRIAL PUMPS**
- These Pumps are either Belt or Gear Box Driven
- Maximum Pump Speed is 1450 RPM
- Easily interchanges with any pump

MODEL	SPECIFICATIONS	NET PRICE
XWM1530	4,350 PSI @ 4.0 GPM	\$ 434.50
XWM2128	4,100 PSI @ 5.5 GPM	\$ 434.50
SXW2135	5,100 PSI @ 5.5 GPM	\$ 447.66
XW3025	3,600 PSI @ 8.0 GPM	\$ 487.00
XWL4215	2,200 PSI @ 11.0 GPM	\$ 520.00

See our Technical Library at <http://www.envirospec.com>

Ceramic Coated Pistons

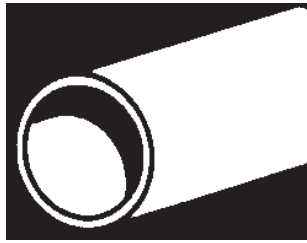

PART #	DESCRIPTION	PRICE
1068	20mm Piston fits: TS-2021, T1011, T1311, T1511, T2011, T2031, T9121, T9131, T9161, T9211, TS821, TS1011, TS1021, TS1041, TS1311, TS1331, TS1351, TS1511, TS1521, TS1531, TS1711, TS2011	\$ 54.89
1069	20mm Piston fits: TS21, TS31, T701, T711, T721, T731, T911, T981, T9721, T9731, T9791, T991, T9951, T9961, T9971	\$ 54.89
1070	15mm Piston fits: EZ3040G, EZ2545G, EZ3035G, EZ2545E, EZ3040S, TT9441, TX1505G6, TX1506G6, TX1508G6, TX1508G8, TX1509G8, TX1510G8	\$ 54.89
1071	22mm Piston fits: T921, T1321, T1621, T1631, T921, TS1321, TS1621	\$ 54.89

High Temp Check Valves

For General Pumps

- The same as a Kit 1 General except it is rated for 185°
- Great for those of you who need to leave the water in by-pass longer than 3 minute intervals



Fits These Pumps

TS2021, TS1011, TS1321, TS1331, TS1511, TS1021, TS1621, TS1711, TS2011, TS821, TT9111, TT941, TT9351, TT9441, TT2028G, TT2028E, TT2035, TT9061, TT9071, T9051, T9721, T9731, T9791, T721, T731, T991, T9951, T9971, T921, T9131, T1011, T1321, 59161, T1511, T1621, T1631, T9211, T2011, T2031, T9281, T9051EBF,

PART #	DESCRIPTION	PRICE
2034	HIGH TEMP KIT GPK101	\$ 98.85

GENERAL PUMP VALUE KITS

High Temp Kit #1

Complete Head Rebuild For
GENERAL PUMPS

- 6 Hi-Temp Check Valves
- 3 Complete Sets of Hi-Temp Packings
- 3 Sets of Packing Brass
- 3 Ceramic Coated Pistons (packings and brass are pre-assembled)



Fits These Pumps

TS-2021, TS2011, T9131, T1011, T9161, T1511, T9211, T2031, TS1021, TS1011, TS1331, TS1511, TS1711, TS821

PART #	DESCRIPTION	PRICE
2035	**E** - HI-TEMP VALUE KIT	\$ 296.65

Standard Kit #2

Complete Head Rebuild - Standard Kits For
GENERAL PUMPS

- 6 Check Valves
- 3 Complete Sets of Standard Packings
- 3 Sets of Packing Brass
- 3 Ceramic Coated Pistons (packings and brass are pre-assembled)



Fits These Pumps

TS-2021, TS2011, T9131, T1011, T9161, T1511, T9211, T2031, TS1021, TS1011, TS1331, TS1511, TS1711, TS821

PART #	DESCRIPTION	PRICE
2036	1 GPK01, 3 GPK28'S, 3 1310-850'S	\$ 263.68

High Temp Kit #3

Check Valves & Packings For
GENERAL PUMPS

- 6 Hi-Temp Check Valves
- 3 Complete Sets of Hi-Temp Packings
- 3 Sets of Packing Brass (packings and brass are pre-assembled)



Fits These Pumps

TS-2021, TS2011, T9131, T1011, T9161, T1511, T9211, T2031, TS1021, TS1011, TS1331, TS1511, TS1711, TS821

PART #	DESCRIPTION	PRICE
2037	1 GPK101, 3 GPK28'S	\$ 186.76

Standard Kit #4

Standard Check Valves & Packings For
GENERAL PUMPS

- 6 Standard Check Valves
- 3 Complete Sets of Standard Packings
- 3 Sets of Packing Brass (packings and brass are pre-assembled)



Fits These Pumps

TS-2021, TS2011, T9131, T1011, T9161, T1511, T9211, T2031, TS1021, TS1011, TS1331, TS1511, TS1711, TS821

Large Frame pumps (over 30 lbs) can handle 145-160° head temperature while smaller pumps handle 130°. A pump will see temps around 175° if you allow the machine to run for more than 3 minutes without pulling the trigger.

PART #	DESCRIPTION	PRICE
2038	1 GPK01, 3 GPK28'S	\$ 139.95

Ask for our Technical Service School & Seminar schedule

GENERAL PUMPS and their KITS

PUMP	Valves	Valve Caps	Packings	Packing w/Brass	Head Rings	Intermediate Ring Kit	Pistons	Piston Bolts	Crankshaft Seal	Oil Seal
CW1012	GPK62	98231200	GPK113	GPK67 (2)	GPK65	69216770	69040109	GPK74	GPK32	GPK37
CW1541	GPK943	98242000	GPK940	GPK939 (3)	GPK41	GPK942	69040009	GPK74	GPK32	GPK32
CW1635	GPK1094	N/A	F1287	GPK1095 (3)	N/A	N/A	F124200310	N/A	N/A	N/A
CW2004	GPK01	GPK04	GPK969	GPK9101A (3)	GPK07	GPK71	1310-850	GPK06	GPK03	GPK02
CW24	GPK01	GPK04	GPK969	GPK9101A (3)	GPK07	GPK71	1310-850	GPK06	GPK03	GPK02
CW3040	GPK01	GPK04	GPK969	GPK9101A (3)	GPK07	GPK71--	1310-850	GPK06	GPK03	GPK02
CW61	GPK943	98242000	GPK940	GPK939 (3)	GPK41	GPK942	69040009	GPK74	76021135	GPK32
CW81	GPK943	98242000	GPK940	GPK939 (3)	GPK41	GPK942	69040009	GPK74	76021035	GPK32
EZ2536E	GPK123	GPK124	GPK127	GPK131 (3)	GPK129	GPK128	44040109	92221600	N/A	GPK23
EZ2542E	GPK123	GPK124	GPK127	GPK131 (3)	GPK129	GPK128	44040109	92221600	N/A	GPK23
EZ2542S	GPK123	GPK124	GPK127	GPK131 (3)	GPK129	GPK128	44040109	92221600	N/A	GPK23
EZ2545E	GPK123	GPK124	GPK88	GPK130 (3)	GPK129	GPK89	1310-852	92221600	N/A	GPK23
EZ2545G	GPK123	GPK124	GPK88	GPK130 (3)	GPK129	GPK89	1310-852	92221600	N/A	GPK23
EZ3035G	GPK123	GPK124	GPK88	GPK130 (3)	GPK129	GPK89	1310-852	92221600	N/A	GPK23
EZ3040G	GPK123	GPK124	GPK88	GPK130 (3)	GPK129	GPK89	1310-852	92221600	N/A	GPK23
EZ3040S	GPK123	GPK124	GPK88	GPK130 (3)	GPK129	GPK89	1310-852	92221600	N/A	GPK23
EZ4040G	GPK123	GPK124	GPK153	GPK156 (3)	N/A	GPK154	44040266	92221600	N/A	GPK23
T1011	GPK01	GPK04	GPK08	GPK28 (3)	GPK7	GPK71	1310-850	GPK06	GPK03	GPK2
T1321	GPK01	GPK04	GPK148	GPK29 (3)	GPK11	GPK149	1310-854	GPK06	GPK03	GPK02
T1511	GPK01	GPK04	GPK08	GPK28 (3)	GPK7	GPK71	1310-850	GPK06	GPK03	GPK02
T1551	GPK43	96242000	GPK113	GPK115 (3)	GPK65	GPK66	76040056	GPK74	GPK32	GPK44
T1621	GPK01	GPK05	GPK148	GPK29 (3)	GPK11	GPK149	1310-854	GPK06	GPK03	GPK02
T1631	GPK01 (2)	GPK04 (2)	GPK148 (2)	GPK29 (6)	GPK11 (2)	GPK149 (2)	1310-854	GPK06 (2)	GPK24	GPK02
T2011	GPK01	GPK05	GPK08	GPK28 (3)	GPK07	GPK71	1310-850	GPK06	GPK03	GPK02
T2031	GPK01 (2)	GPK04 (2)	GPK08 (2)	GPK28 (6)	GPK07 (2)	GPK71 (2)	1310-850	GPK06 (2)	GPK24	GPK02 (2)
T41	GPK62	99366900	GPK38	GPK39 (3)	GPK41	GPK42	69040009	GPK74	GPK32	GPK37
T4251	GPK122	99486000	GPK77	GPK78 (3)	GPK07	GPK75	61040056	61219566	GPK32	GPK44
T5050	GPK150	99428200	GPK109	GPK151 (3)	GPK108	GPK110	47040856	47219666	GPK03	GPK02
T61	GPK43	98242000	GPK79	GPK80 (3)	GPK48	GPK81	76040209	GPK74	GPK32	GPK44
T721	GPK01	GPK04	GPK19	GPK27 (2)	GPK21	GPK20	1310-851	GPK06	N/A	GPK23
T731	GPK01	GPK04	GPK19	GPK27 (2)	GPK21	GPK20	1310-851	GPK06	N/A	GPK23
T81	GPK43	98242000	GPK79	GPK80 (3)	GPK48	GPK81	76040209	GPK74	GPK32	GPK44
T9051	GPK01	GPK84	GPK97	GPK96 (3)	--	--	51040009	--	90164400	GPK83
T9131	GPK01	GPK04	GPK08	GPK28 (3)	GPK7	GPK71	1310-850	GPK06	GPK03	GPK02
T9161	GPK01	GPK05	GPK08	GPK28 (3)	GPK7	GPK71	1310-850	GPK06	GPK03	GPK02
T921	GPK01	GPK04	GPK148	GPK29 (3)	GPK11	GPK149	1310-854	GPK06	GPK03	GPK02
T9211	GPK01	GPK05	GPK08	GPK28 (3)	GPK7	GPK71	1310-850	GPK06	GPK03	GPK02
T9281	GPK01	GPK106	GPK109	GPK112 (3)	GPK108	GPK110	47040856	GPK107	GPK03	GPK02
T9721	GPK01	GPK04	GPK19	GPK27 (3)	GPK21	GPK20	1310-851	GPK06	N/A	GPK23
T9731	GPK01	GPK04	GPK19	GPK27 (3)	GPK21	GPK20	1310-851	GPK06	N/A	GPK23
T9791	GPK01	GPK04	GPK19	GPK27 (3)	GPK21	GPK20	1310-851	GPK06	N/A	GPK23
T991	GPK01	GPK04	GPK19	GPK27 (3)	GPK21	GPK20	1310-851	GPK06	N/A	GPK23
T9951	GPK01	GPK04	GPK19	GPK27 (3)	GPK21	GPK20	1310-851	GPK06	N/A	GPK23

GENERAL PUMPS and their KITS

PUMP	Valves	Valve Caps	Packings	Packing w/Brass	Head Rings	Intermediate Ring Kit	Pistons	Piston Bolts	Crankshaft Seal	Oil Seal
T9971	GPK01	GPK04	GPK19	GPK27 (3)	GPK21	GPK20	1310-851	GPK06	90164400	GPK23
TS1011	GPK01	GPK04	GPK08	GPK28 (3)	GPK07	GPK71	1310-850	GPK06	GPK03	GPK02
TS1021	GPK01	GPK04	GPK08	GPK28 (3)	GPK07	GPK71	1310-850	GPK06	GPK03	GPK02
TS1041	GPK62	--	GPK08	GPK82 (3)	GPK07	GPK71	1310-850	GPK54	GPK03	GPK37
TS1321	GPK01	GPK04	GPK12	GPK29 (3)	GPK11	GPK149	1310-854	GPK06	GPK03	GPK02
TS1331	GPK01	GPK04	GPK08	GPK28 (3)	GPK07	GPK71	1310-850	GPK06	GPK03	GPK02
TS1511	GPK01	GPK04	GPK08	GPK28 (3)	GPK07	GPK71	1310-850	GPK06	GPK03	GPK02
TS1531	GPK62	98231200	GPK08	GPK82 (3)	GPK07	GPK71	1310-850	GPK54	GPK32	GPK37
TS1621	GPK01	GPK05	GPK12	GPK29 (3)	GPK29	GPK1497	1310-854	GPK06	GPK03	GPK02
TS1711	GPK01	GPK04	GPK08	GPK28 (3)	GPK07	GPK71	1310-850	GPK06	GPK03	GPK02
TS2011	GPK01	GPK05	GPK08	GPK28 (3)	GPK07	GPK71	1310-850	GPK06	GPK03	GPK02
TS2021	GPK01	GPK05	GPK08	GPK28 (3)	GPK07	GPK71	1310-850	GPK06	GPK03	GPK02
TS821	GPK01	GPK04	GPK08	GPK28 (3)	GPK07	GPK71	1310-850	GPK06	GPK03	GPK02
TS921	GPK01	GPK04	GPK148	GPK29 (3)	GPK11	GPK149	1310-854	GPK06	GPK03	GPK02
TSF2019	GPK169	66130041	GPK170	GPK171 (3)	--	66216070	66040009	99380100	GPK03	GPK02
TSF2021	GPK169	66130041	GPK170	GPK171 (3)	--	66216070	66040009	99380100	GPK03	GPK02
TSF2219	GPK169	66130041	GPK172	GPK173 (3)	--	66216070	66040109	99380100	GPK03	GPK02
TSF2221	GPK169	66130041	GPK172	GPK173 (3)	--	66216070	66040109	99380100	GPK03	GPK02
TSF2421	GPK169	66130041	GPK181	GPK182 (3)	--	66216070	66040409	99380100	GPK03	GPK02
TSP1621	GPK150	66130041	GPK174	GPK175 (3)	--	66216070	66040209	99380100	GPK03	GPK02
TSP1819	GPK150	66130041	GPK161	GPK176 (3)	--	66216070	66040309	99380100	GPK03	GPK02
TSP1821	GPK150	66130041	GPK180	GPK176 (3)	--	66216070	66040309	99380100	GPK03	GPK02
TT2028E	GPK01	GPK84	GPK97	GPK96 (3)	51100051	--	51040009	--	--	GPK83
TT2028G	GPK01	GPK84	GPK97	GPK96 (3)	--	--	51040009	--	--	GPK83
TT2035	GPK01	GPK84	GPK97	GPK96 (3)	--	--	51040009	--	--	GPK83
TT9061	GPK01	GPK84	GPK97	GPK96 (3)	--	--	51040009	--	--	GPK83
TT9071	GPK01	GPK84	GPK97	GPK96 (3)	--	--	51040009	--	--	GPK83
TT9111	GPK01	GPK84	GPK141	GPK140 (3)	--	--	51040109	--	--	GPK83
TT9351	GPK01	GPK04	GPK88	GPK92 (3)	GPK90	GPK89	1310-852	--	--	GPK23
TT941	GPK01	GPK84	GPK97	GPK96 (3)	--	--	51040009	--	--	GPK83
TT9441	GPK01	GPK04	GPK88	GPK92 (3)	GPK90	GPK89	1310-852	--	--	GPK23
TX1505G6	GPK123	GPK124	GPK160	GPK166 (3)	--	GPK164	1310-852	--	--	GPK159
TX1506G6	GPK123	GPK124	GPK160	GPK166 (3)	--	GPK164	1310-852	--	--	GPK159
TX1508G6	GPK123	GPK124	GPK160	GPK166 (3)	--	GPK164	1310-852	--	--	GPK159
TX1508G8	GPK123	GPK124	GPK160	GPK166 (3)	--	GPK164	1310-852	--	--	GPK159
TX1509G8	GPK123	GPK124	GPK160	GPK166 (3)	--	GPK164	1310-852	--	--	GPK159
TX1510G8	GPK123	GPK124	GPK160	GPK166 (3)	--	GPK164	1310-852	--	--	GPK159



WE CARRY THE COMPLETE LINE OF PUMP REPAIR KITS FOR:



In 1976 a Mobile Washer by the name of John Allison started manufacturing his own

PROFESSIONAL MOBILE WASH CHEMICALS

in the field & under actual cleaning conditions where it really counts. Why? He realized that if he was going to stay in this industry he had to learn how to make products that work - work fast & work safely. He did just that!

Below are some facts that John feels every Mobile Washer should be aware of.

FACT #1: If you are not using a non-caustic cleaning chemical like mine, there is a good chance that you are cleaning with the same chemicals that are found in Paint Strippers, Oven Cleaners or Drain Cleaners. Check the MSDS sheet on your cleaning chemicals for Sodium Hydroxide or Potassium Hydroxide. Sodium Hydroxide and Potassium Hydroxide are used in the detergent industry because they are relatively cheap to build & appear to clean great. When using cleaning chemicals with these ingredients, the operator will see a dramatic reaction as the dirt starts rolling off. What is happening is that a microscopic layer of paint is actually being stripped away and the dirt is coming off along with it. Fleet Washers often call us about problems that they are having with chemicals they have purchased elsewhere and they will tell us that they have a 'chalky film' or a 'dull finish' on the vehicles after a couple of washes. The answer to their question as to why this is happening is quite simple - they are using a cleaner containing Sodium Hydroxide or Potassium Hydroxide & it is literally destroying the paint. EnviroSpec's Cleaning Chemicals work so well because we use expensive, high yield surfactants, additives and gloss enhancers. While most commercial cleaning chemical manufacturers use 2 or 3 raw materials in their compounding process, we use 8 to 12 specialty products in all of our formulations. This is one reason why EnviroSpec Cleaning Chemicals will perform way beyond your greatest expectations.

FACT #2: If your cleaning chemical has a residual floating on top or settling to the bottom, more than likely that product contains a lot of 'fillers'. Fillers are very low cost additives that most manufacturers use to add weight and bulk but do nothing to add to the performance of the product. The general rule in the detergent industry that oftentimes determines the quality of the product is as follows; If you mix one pound of product to one gallon of water & you do not have any floating or settling, you have a respectable product which is 'filler' free.

Also it is extremely difficult to add more than one pound of powder to one gallon of water and to keep it from 'falling out' of solution. To our knowledge EnviroSpec is the only chemical manufacturer in the industry that can mix over 3 pounds of most of our products to one gallon of water and the product will stay in solution. If you are wondering why we go to such extremes to make the best product available anywhere, it's because we were once Mobile Washers just like you and we was not satisfied with what was available so we developed our own. Here is the funny part - as small as we are our products go up against the largest detergent companies in the World every day and we walk away the winner - not sometimes but almost every time. The only time we don't is when we find a Mobile Washer who insists on 'burning' the dirt off with the caustics mentioned above.

FACT #3: Another fact is that we don't lose customers. Once someone tries my products, they keep buying them. Years ago when I first started my mobile wash business I purchased almost everyone's 'claim to fame' detergents. I realized that if I was going to stay in the mobile wash business that I had better learn how to compound my own chemicals. Since that time I am confident that no-one can compete with my products and win, no one! We have been manufacturing and selling cleaning chemicals for many years and...

...we just don't loose customers because they found a better product!



How Good are Our Products?

Well, how about a

100% GUARANTEE

that you will be

COMPLETELY SATISFIED?

'Chemicals manufactured by a
Mobile Washer for Mobile Washers'



EnviroSpec - 'Full Dress' Chemicals Worth Taking Out On The Town!



Environment Friendly
Cleaning Chemicals

from

ENVIROSPEC

SuperFlo Polymer® Technology...

for a Clean and Shine that Lasts and Lasts!

EnviroSpec Surface Cleaning Products are the only appearance products on the market containing...

...SuperFlo Polymer® finish protectors.

SuperFlo Polymer® forms an invisible protective barrier so dirt, mud and road grime have a hard time sticking to the surface.



ENVIROSPEC'S

Soap for Hope

CHARITIES

EnviroSpec donates 100% of the after tax profits from our Chemical Sales to Animal Charities such as Suzie's Friends Animal Shelter, The Humane Society of the United States, ASPCA, Local Animal Shelters, Humane Societies and Rescues in other areas of the country as well as the Jekyll Island, Georgia Spay/Neuter Program.



Please consider helping a Shelter or Rescue in your area.
It's a great feeling knowing that you have helped a forgotten, helpless & hungry animal.



1-800-346-4876 or visit us on-line at <http://www.envirospec.com>

For Scheduled Truck & Bus Fleet Washing

VIPER

Specifically developed for the
Truck & Bus Washing Industry

for Contractors who have their customers on a specific cleaning schedule.

Viper is Non-Caustic and contains - CARBON RELEASE ACTIVATOR & GLOSS ENHANCERS

Viper is a specialty product specifically formulated for the Truck Washing & Bus Washing Industry where exhaust fumes have become attached to the stack side of the trailer body & rear engine areas of City Buses. Coupled with carbon release activating solvents and rinse aids, Viper also finds itself being utilized in other areas where the heavy build-up of grease & oil is present. Garage Floors, Vehicle Maintenance Shops, and Service Stations are just a few of the many areas where Viper is utilized.

Viper is preferred by many professionals who have scheduled cleaning of commercial vehicles with a frequency of weekly or every other week service. It is a quick cleaner and a fast rinsing. Areas where this product is being utilized is on Hertz, UPS, Ryder and many other Nationally known vehicle accounts.

Viper exhibits excellent wetting, chelating, rinsing and emulsifying properties. It has the ability to hold pollutants in suspension during the wash process and it's rinsability makes it an ideal product when using either cold or hot water equipment.

Viper's horsepower is derived from a group of Specialty Gloss Enhancers, Spot Free Rinse Aids, and a unique blend of surfactants which are not commonly found in the detergent industry.

Viper comes packaged in a two-part system. One part is approximately forty (40) pounds of Base Product. The second part is one gallon of Carbon Release Activator. The two combined will make 55 gallons of a super concentrate.

PART #	NOTES:	NET PRICE
ZPVIP	1 EACH - 55 GALLON DRUM KIT	\$98.90
'Mix & Match' any 6 Drum Kits and WE PAY THE FREIGHT!		
Freight Program is only available in the continental USA CANADA & all others receive a \$15.00 per box freight allowance.		
VIP5	8 GALLON POWER PACK KIT	\$20.00

The Industry's Only 'FILM FREE' Truck Wash

BOND BREAKER

Bond Breaker is the most incredible product of its kind in the industry. Never has anyone been able to remove as much of the film caused by electromagnetic bonding of particles which results as the vehicle cuts it's way through the wind.

Typically this attempt is performed through the use of caustics such as Sodium or Potassium Hydroxides which are typically found in the paint stripping or exhaust hood cleaning industries. Never should these products be utilized to clean painted vehicles. Yes, when applied the dirt and debris starts to roll off the surface but behind that dirt is a microscopic layer of the surface coming with it. As the process continues the vehicle surfaces become dull.

Bond Breaker utilizes a unique blend of products to break the magnetic field which holds the film particles on the surface. Given the best of all the elements, soft water, ambient temperatures and cleaning methods, Bond Breaker will remove 99% of all film from the surface. Worst case scenario you can expect 95%-97% removal.

Our development model for Bond Breaker was as follows:

- 1) It had to have an extremely quick reaction time yet Safe to use.
- 2) It had to dissolve grease and carbon on contact with minimum dwell time
- 3) It had to produce a minimum of 92% film free surface.
- 4) It had to have exceptional rinsing characteristics.

Bond Breaker is not for everyone. It is an expensive product to formulate and stabilize. It is aimed at a unique market that demands the very best and expects it to perform accordingly.

PART #	NOTES:	NET PRICE
ZPBON	1 EACH - 55 GALLON DRUM KIT	\$159.34
'Mix & Match' any 6 Drum Kits and WE PAY THE FREIGHT!		
Freight Program is only available in the continental USA CANADA & all others receive a \$15.00 per box freight allowance.		
BB5	8 GALLON POWER PACK KIT	\$20.00

Mix & Match any FREE FREIGHT Product to achieve the Buy 6 Requirement

The Industry's #1 Selling Truck Wash

PRODIGY

Since 1986

Prodigy has been our #1 Selling Truck Wash

Prodigy is, by far, one of the highest non-caustic detergent concentrations available in the industry. Prodigy exhibits excellent wetting, chelating, rinsing, and emulsification properties due to its high concentration of our SuperFlo Polymer Complex System. This exotic complex is formulated from a variety of unique dispersants, hydrotopes, and surfactants, which are not commonly found in detergent formulations.

The general rule of thumb in detergent formulation is as follows: Approximately 1 gallon of water will hold approximately 1 pound of powder before separation begins. If your product begins to separate using this method, more often than not, your product has been camouflaged with what is known in our industry as "fillers". Fillers provide little to no value to the products integrity and/or performance. They are used primarily to add weight and increase the bottom line profit for the manufacturer. Using the 1 pound per 1 gallon rule, you can see the potency of Prodigy when you consider that we are able to thoroughly dissolve up to 2.3 pounds of Prodigy into 1 gallon of water without separation. To our knowledge, no other company can make this claim. The advantage of these concentration levels are twofold: 1) the contractor is now able to clean substrates that normally require the use of caustic cleaners and 2) work faster and safer, which increases your bottom line.

As the leader in contract cleaner formulations, EnviroSpec goes to great lengths in providing products that are both environment friendly as well as effective, an attitude not commonly found in such a demanding industry.

Since PRODIGY came out in 1986 it has grown to be the most asked for Truck Wash Detergent in the Professional Mobile Wash Industry.

PART #	NOTES:	NET PRICE
ZPPRO	1 EACH - 55 GALLON DRUM KIT	\$99.50
'Mix & Match' any 6 Drum Kits and WE PAY THE FREIGHT!		
Freight Program is only available in the continental USA CANADA & all others receive a \$15.00 per box freight allowance.		
PRO5	8 GALLON POWER PACK KIT	\$20.00

Powerful 'Super Solvent' Truck Wash / Degreaser

MR. MUSCLE

For Super Heavy Duty Degreasing Non-Caustic & Phosphate Free

Mr. Muscle has a 45 pound base of Prodigy, the industry's #1 Selling Tractor/Trailer Wash, plus a unique 2.5 gallon solvent/surfactant additive that really cranks up the horsepower and safely cuts through the heavy build-up of carbonaceous pollutants such as the exhaust typically found on over-the-road trailer bodies and 'fifth-wheel grease!'

Mr. Muscle walks circles around all the degreasers found in the marketplace and at a price that is well below what you would expect to pay for such a product.

In addition, you will find it to work extremely well with both hot and cold water systems. The addition of SpeedX-777 which is part of the liquid additive makes rinsing a breeze.

Mr. Muscle exhibits excellent wetting, chelating, rinsing, and emulsification properties due to its high concentration of our SuperFlo Polymer Complex System. This exotic complex is formulated from a variety of unique dispersants, hydrotopes and rinse aids which are not commonly found in detergent formulations.

Typical applications for the concentrate are:

Tractor/Trailer Bodies, Engines, Fork Lifts, Garage Floors, Rail Cars

As the leader in contract cleaner formulations, EnviroSpec goes to great lengths in providing products that are both environment friendly as well as effective, an attitude not commonly found in such a demanding industry.

PART #	NOTES:	NET PRICE
ZPMRM	1 EACH - 55 GALLON DRUM KIT	\$159.34
'Mix & Match' any 6 Drum Kits and WE PAY THE FREIGHT!		
Freight Program is only available in the continental USA CANADA & all others receive a \$15.00 per box freight allowance.		
MRM5	8 GALLON POWER PACK KIT	\$20.00

High Foaming Car, Truck & House Wash

FOAM-N-SHINE

**SINGLE PASS CLEANING! INCREDIBLY FAST RINSING!
GREAT SHINE!
HIGH FOAM CLEANING! SOLVENT FREE!**

That is what the 'Foam-N-Shine' Formula is all about!

Using the finest builders in the industry and adding in specific water softening and foaming additives plus a blend of unique 'chelating agents' which 'tie up' the metallic ions in water has resulted in that 'always looked for' but 'seldom found' black magic formula that we now call...

FOAM'N-SHINE

FOAM-N-SHINE exhibits excellent wetting, chelating, rinsing and emulsification properties due to its high concentration of our SuperFlo Polymer Complex System. This exotic complex is formulated from a variety of unique dispersants, hydrotopes, and surfactants which are not commonly found in detergent formulations. With this 'double dose' of SuperFlo Polymer you can expect exceptional brilliance on most surfaces.

FOAM-N-SHINE dramatically reduces surface tension so pollutants 'roll-off' the surface with ease without having to brush. With special wetting agents you will find that FOAM-N-SHINE keeps the surface wetter longer allowing the contractor more flexibility in washing larger areas without having to worry about the surface drying before rinsing.

FOAM-N-SHINE works extremely well with cold water or hot water equipment.

PART #	NOTES:	NET PRICE
ZPFNS	1 EACH - 55 GALLON DRUM KIT	\$104.40
'Mix & Match' any 6 Drum Kits and WE PAY THE FREIGHT! Freight Program is only available in the continental USA CANADA & all others receive a \$15.00 per box freight allowance.		
FSS	8 GALLON POWER PACK KIT	\$20.00

Extra Water Softeners - Cold Water Truck & House Wash

PRO-BLEND

'Film Free' Cleaning in the Truck & House Washing Industry

Features:

**SuperFlo Polymer Gloss Enhancers
Water Softening Additives
Nonionic Surfactant Base**

Pro Blend is, by far, the most effective non-caustic, film free cleaning detergent concentrate in the professional contract cleaning industry. When used properly, the operator can expect to remove 85% to 90% of all road film from both tractor and trailer bodies that are cleaned on a regular basis.

Pro Blend exhibits excellent wetting, chelating, rinsing and emulsification properties due to its high concentration of our SuperFlo Polymer Complex System. This exotic complex is formulated from a variety of unique dispersants, hydrotopes, and surfactants which are not commonly found in detergent formulations.

The power from Pro Blend originates from a wide variety of uniquely charged ion surfactants, which will alter a positive charged substrate to a negative charge upon contact. This bond breaking function will provide the operator with a one-step cleaning process, rather than the typical acid-alkaline or two-step process that is presently being utilized throughout the industry. The advantages of single step cleaning, using Pro Blend, are twofold, 1) the contractor will be able to provide his/her customer with a much higher quality service, at a much lower cost, or should they choose, greatly enhance their own profit margin, and 2) eliminates the possibility of etching glass which can easily happen when using solutions with a hydrofluoric acid content.

PART #	NOTES:	NET PRICE
ZPPROB	1 EACH - 55 GALLON DRUM KIT	\$93.41
'Mix & Match' any 6 Drum Kits and WE PAY THE FREIGHT! Freight Program is only available in the continental USA CANADA & all others receive a \$15.00 per box freight allowance.		
PB5	8 GALLON POWER PACK KIT	\$20.00

Mix & Match any FREE FREIGHT Product to achieve the Buy 6 Requirement

Truck Wash for Cold Water Pressure Washers

NEVER DULL

For vehicles with high end appearance such as Polished Aluminum Tanks, Imron Paint & Expensive Lettering.

Never Dull is the preferred product for Vehicles that are, without question, products of an image conscious customer. A lot of time and expense goes into the production of such vehicles. Imron paint itself is very expensive as is the lettering and graphics that present the company's position in the marketplace. With all this in mind, however, nothing, absolutely nothing will get a fleet owner more upset or irritated than when you 'dull' their polished aluminum tanks.

When used according to our recommendations Never Dull is the perfect cold water product that has a unique blend of citrus solvents, surfactants & chelators that we've designed specifically for those trucks that need a product 'tuff' enough to remove carbonaceous pollutants such as grease and fuel over-spill as well as general fallout pollutants, yet gentle enough to clean tanks and never leave them looking dull.

Along with these special blends, Never Dull also has a 'double dose' of Speed -X 777 which keeps the pollutant in solution not allowing it to redeposit itself elsewhere on the surface prior to rinsing. This product is recommended to be used with cold water equipment. The reasoning behind this is because heat generates alkalinity and since Never Dull has a specific balancing of "builder to surfactant" the introduction of heat (hot water) makes it's design both unpredictable and uncontrollable.

In order to avoid 'alkaline shock' remember to cool down the surface prior to product application.

You will find Never Dull the perfect blend for those 'perfect vehicle finishes.'

PART #	NOTES:	NET PRICE
ZPND	1 EACH - 55 GALLON DRUM KIT	\$107.69
'Mix & Match' any 6 Drum Kits and WE PAY THE FREIGHT!		
Freight Program is only available in the continental USA CANADA & all others receive a \$15.00 per box freight allowance.		
ND5	8 GALLON POWER PACK KIT	\$20.00

Truck Wash With Extra Carbon Release Activators

RELEASE

NON-CAUSTIC FORMULA

with 'HIGH YIELD' CARBON RELEASE SOLVENTS & GLOSS ENHANCERS

RELEASE is a high solvent, medium duty vehicle detergent for finer finishes than typically found on 'over the road' Tractors, Trailers & Straight Trucks. This product would be your first choice for vehicles that are washed weekly or every other week. Vehicles such as package delivery, school buses, airport shuttle vehicles that do not see heavy road use but are exposed to carbonaceous pollutants typically found in 'close quarter' operation would be good candidates for RELEASE.

Companies whose vehicles are presently being cleaned with the RELEASE formula are Hertz, UPS, FEDX, DHL and New York Airports not to mention thousands of School Buses. This product was developed while cleaning Connecticut Natural Gas vehicles in the 1980's and have been an industry favorite ever since.

RELEASE is a non-caustic detergent concentrate that contains Gloss Enhancing additives that will help to keep vehicles looking good longer. This product will not harm delicate graphics typically found on such vehicles.

Release exhibits excellent wetting, chelating, rinsing and emulsification properties. Its ability to hold pollutants in suspension during the wash process and not allowing them to be redeposited makes it an ideal product when using cold or hot water systems. The unique 'grease release' activator in RELEASE quickly removes oil/grease pollutants from the substrate.

Release comes packaged in a two-part system. One part is approximately forty pounds of Release Base Product & the second part is one gallon of Carbon Release Activator. When mixed they make 55 gallons of a super concentrate with a very long shelf life.

PART #	NOTES:	NET PRICE
ZPREL	1 EACH - 55 GALLON DRUM KIT	\$104.40
'Mix & Match' any 6 Drum Kits and WE PAY THE FREIGHT!		
Freight Program is only available in the continental USA CANADA & all others receive a \$15.00 per box freight allowance.		
REL5	8 GALLON POWER PACK KIT	\$20.00

Mix & Match any FREE FREIGHT Product to achieve the Buy 6 Requirement

Bleach Friendly HOUSE WASH with Gloss Enhancers

EMULSIFIER PLUS

BLEACH FRIENDLY DETERGENT

For the very best of all worlds start with 4 gallons of Emulsifier Plus to 1 Gallon of Bleach

Emulsifier Plus - is one of the Original House Wash Formulas developed by EnviroSpec. Our dilemma at the onset of its development stages were: we all knew bleach works better than anything for killing and cleaning mold & mildew but we also knew that bleach does absolutely nothing about cleaning carbonaceous pollutants such as exhaust carbons, dirt, grease and grime. The task was - how to do both at the same time!

Bleach, for the most part, does not like to be blended with other chemical products and many of the chemical products found in the professional mobile wash industry can create a serious explosive situation when mixed with sodium hypochlorite (bleach). Emulsifier Plus, on the other hand, is the answer to both the safety issue as well as the cleaning problem. These two products work extremely well together when blended and applied in accordance with the EnviroSpec instructions. Have the best of both worlds - Clean and Kill Mildew and Clean All the other Pollutants typically found on an exterior substrate. And do it all in one pass!

Emulsifier Plus has a pH of around 11.8 to 12.0 in a 1% solution. This unique blend of Surfactants & Builders has been specifically formulated for the House Wash Industry as a stand alone detergent or a detergent additive to be blended together with Bleach.

Emulsifier Plus works great on removing heavy build-ups of grease, grime and general fallout pollutants generally found in high traffic areas and exhibits excellent wetting, chelating, rinsing, and emulsification properties. Its ability to hold pollutants in suspension during the wash process makes it an ideal product when using either hot or cold water pressure washers.

PART #	NOTES:	NET PRICE
ZPEMUP	1 EACH - 55 GALLON DRUM KIT	\$93.41
'Mix & Match' any 6 Drum Kits and WE PAY THE FREIGHT!		
Freight Program is only available in the continental USA CANADA & all others receive a \$15.00 per box freight allowance.		
EMUPS	8 GALLON POWER PACK KIT	\$20.00

Best Product for Blue, Red, Brown & Green Siding

PREMIER

Specifically Formulated for Dark Colored Siding where Oxidation is Present

After cleaning Premier leaves a SILICONE MEMBRANE on the surface which is designed to retard the formation of mildew and to keep general 'fall-out' pollutants from adhering to the surface..

Premier would also be your first choice for cleaning new homes in a housing development where the pollutant being cleaned is primarily mildew. This type of cleaning does not require the solvent but only mildew release agents and gloss enhancing additives. Premier would also be a great choice for houses or mobile homes that are cleaned annually.

Premier takes a bow for impressive performance in providing a thorough wash/rinse cycle while remaining gentle on new aluminum, vinyl and wood siding.

PREMIER is a unique blend of specialty surfactants and alkalis specifically formulated for the Professional Exterior House Washing Industry. It acts by first wetting and chelating pollutants and then holding them in suspension until the surface is thoroughly rinsed.

PREMIER is less aggressive on surface and vegetation than typical cleaners used in this field but will achieve superior cleaning results.

Premier is ideally suited for both a hot and cold water pressure washers. By chelating of both calcium and iron in water and a unique water softening additive Premier will provide 'spot free' rinsing when used in accordance with the manufacturers instructions.

PART #	NOTES:	NET PRICE
ZPPRE	1 EACH - 55 GALLON DRUM KIT	\$93.41
'Mix & Match' any 6 Drum Kits and WE PAY THE FREIGHT!		
Freight Program is only available in the continental USA CANADA & all others receive a \$15.00 per box freight allowance.		
PRE5	8 GALLON POWER PACK KIT	\$20.00

Mix & Match any FREE FREIGHT Product to achieve the Buy 6 Requirement

EARTH FRIENDLY - HEAVY DUTY DETERGENT - With a lot of Kick!

BIO-GREEN

Until now - most 'so called' environment friendly cleaners have been little more than 'watered down' products that have been sold under another name.



Choosing environmentally friendly cleaning products and eliminating toxic ones has always been what EnviroSpec is all about and Bio-Green is the latest addition to our arsenal of environment friendly products.

Bio-Green, a variation of the Limonene family, is the answer to everyone's concerns about Earth Friendly products that really can clean.

Bio-Green is truly a workhorse in the industrial and institutional detergent industry. Known for consistency, EnviroSpec, has developed this product to be the answer to all of the concerns in the vehicle cleaning and house washing industry as well as other projects requiring special surface active properties.

Bio-Green offers excellent and economical detergency, foaming, wetting, emulsification and biodegradability needed for today's specialized high performance cleaning products. It has excellent foaming at actual 'use' dilutions which will provide the user with the necessary visual requirements to determine concentration levels on the surface being cleaned.

Yes, Bio-Green can respond to your toughest needs, whether it's a medium duty truck or house wash job or a 'down and dirty' forklift with years of grease and grime. And it can do all this and still be gentle on the world we live in.

PART #	NOTES:	NET PRICE
ZPBG	1 EACH - 55 GALLON DRUM KIT	\$104.40
'Mix & Match' any 6 Drum Kits and WE PAY THE FREIGHT!		
Freight Program is only available in the continental USA CANADA & all others receive a \$15.00 per box freight allowance.		
BG5	8 GALLON POWER PACK KIT	\$20.00

With Mildew Release Solvents & Gloss Enhancers

LIMONENE



The Industry's #1 SELLING Exterior House Wash

In recent years the evolution of the environment conscious homeowners are becoming much more educated in the field of exterior house washing. They are saying 'no-more' to the contractors who are using the unfriendly bleach that has been so popular for so long simply because it is inexpensive to purchase and, until now, there have been few alternatives for removing mold and mildew.

The solvency in Limonene originates from citrus by-products such as orange and lime peels. These solvents, coupled with specific pH balanced surfactants and builders, provide the contractor with an excellent product that quickly removes carbonaceous pollutants such as oil and grease and other fallout pollutants commonly found in the house washing industry. Pollutants such as gutter streaks, mold/mildew, etc. For the first time ever they are experiencing safe and effective surface chemistry that deals with wood, aluminum and vinyl siding and the pollutants common to those surfaces.

Limonene has excellent hydrotoping characteristics through the use of a unique dispersant complex which is not commonly found in detergent chemistry. This complex, known as SuperFlo Polymer, has been developed by EnviroSpec and is found throughout our detergent formulary because of its tremendous ability to add horsepower to virtually every type of alkali detergent products while remaining much more gentle than the alternatives. You will find that Limonene has superior rinsing qualities in both hot and cold water environments which results in cleaning faster and safer. **Contractors who have used Limonene - DON'T STOP!**

PART #	NOTES:	NET PRICE
ZPLIM	1 EACH - 55 GALLON DRUM KIT	\$107.69
'Mix & Match' any 6 Drum Kits and WE PAY THE FREIGHT!		
Freight Program is only available in the continental USA CANADA & all others receive a \$15.00 per box freight allowance.		
LIM5	8 GALLON POWER PACK KIT	\$20.00

Helps Bond Paint to Surface

PREP-EZZ

PRE-PAINT SURFACE PREP & PAINT BONDING

Used By Professional House Painters Everywhere

who do not want to do the job over because the paint did not adhere to the surface

There is nothing, absolutely nothing on the market that will prepare a surface for longer lasting paint adhesion than PrepEZZ.

This non-caustic, specialty solvent based pre-paint prep product has been specifically formulated to safely remove surface oxidation, mildew and general fallout pollutants prior to painting while leaving behind a unique 'paint to surface' bonding environment.

When used properly PrepEZZ will insure that your finished product will last many years longer than what you would normally expect based on paint manufacturers claims. Our unique SuperFlo Polymer Additive, an EnviroSpec exclusive, charges the surface in such a manner that 'locks down' paint adhesion. Used properly the professional painting contractor can be assured that they will never be called back to the job site because the paint is "lifting" or "flaking".

PrepEZZ is sold in a 20 gallon kit form so the painting contractor will be able to easily dissolve the pre-mix formula into solution as needed.

PrepEZZ can be used with hot or cold pressure washers and does not contain harmful caustics or bleach.

The Ultimate
SURFACE CLEANING & PAINT BONDING PRODUCT IN THE INDUSTRY.

Industry's Most Concentrated Oxygen Cleaner

RESTORE

Simply Put? Awesome! Brings Old Wood back to NEW

Cedar Shakes & Unpainted Wood Surfaces such as Decks - Stripping Antique Furniture - Cleaning Tile Grout - Laundry Presoak & Bleach Replacement - Carpet Cleaning ... *you just won't find anything better than RESTORE!*

For Cedar Shakes and unpainted Wood Decks simply spray RESTORE on, wait 20 to 30 minutes, and rinse off. You will not believe your eyes! No more harsh bleach or surface and vegetation aggressive chemicals. Totally removes black mold and mildew build-up on shakes, regardless of how long it has been there.

RESTORE works by means of oxygenation and should not be mixed with water until the operator is ready to perform the job. Once RESTORE is in solution, the operator will have approximately 1-2 hours before the product has exhausted itself. Mix up enough so that you will be able to get the product on the surface within this time. Mix approximately 1/2 to 1 pound of RESTORE into 1 gallon of water and stir several turns. Complete solubility is not necessary since RESTORE will go into solution on it's own through the oxygenation process. Using a ShurFlo Pump place the pick-up line in the solution and spray product directly onto the surface. When product has removed pollutant, rinse with low pressure, 500 - 1000 PSI is all that is required. When using this product on pressure treated wood we recommend the 1/2 lb to 1 gallon of water ratio and rinsing with no more than 500 PSI. Higher dilutions and pressures will cause the surface to 'fuzz' up. When this happens it is generally a temporary situation that will correct itself in a couple of days. Do not use a pump-up sprayer to apply Restore since this product builds pressure when added to water and will over pressurize the sprayer which could result in an injury should the sprayer erupt.

This product will provide unbelievable results. You will be able to produce twice the results in 1/3 the time and with little to no mess. You'll never use harsh chlorine cleaners or solvent based strippers again.

PART #	NOTES:	NET PRICE
ZPPREP20	1 EACH - 20 GALLON DRUM KIT (20 LBS)	\$49.45
QUALIFIES FOR FREE FREIGHT		
Freight Program is only available in the continental USA. CANADA & all others receive a \$15.00 per box freight allowance. 2 ea. ZPPREP = 1 of this product in figuring freight allowance.		

PART #	NOTES:	NET PRICE
ZPRES40	1 EACH - 40 TO 55 GALLON DRUM KIT	\$75.30
'Mix & Match' any 6 Drum Kits and WE PAY THE FREIGHT!		
Freight Program is only available in the continental USA CANADA & all others receive a \$15.00 per box freight allowance.		
RESS	5 GALLON POWER PACK KIT	\$20.00

Mix & Match any FREE FREIGHT Product to achieve the Buy 6 Requirement

Hi-Foam, Hi-Shine, No Solvent House Washing

POWER HOUSE

Specifically Formulated for COLD WATER EQUIPMENT IN HARD WATER AREAS

POWER HOUSE was developed for cold water washing where hard water is present. This product contains an over abundance of water softening chelating agents which makes it well suited for hard water areas throughout the country. Typically hot water is the preferred method of applying and rinsing cleaning chemicals from the surface. However, you will find POWER HOUSE to work equally as well in a cold water environment. This is especially important in States like Florida, Georgia & Texas where it is not uncommon to see surface temperatures in the 130 degree range. Since heat generates alkalinity you can see how dangerous it can be when detergent is applied to the surface using a hot water pressure washer. Quite often this method results in alkaline shock where the water from the detergent evaporates and damages the surface before the operator has time to rinse. More often than not this damage is irreversible. Use POWER HOUSE to avoid this danger.

The dispersant utilized in POWER HOUSE allows for a high concentration of specific builders and surfactants which will completely emulsify carbonaceous as well as general 'fall-out' pollutants commonly found in areas that see a lot of motor vehicle traffic. POWER HOUSE contains a high volume of our SuperFlo Polymer which accounts for its surface gloss.

Although POWER HOUSE is considered a Super Concentrate you will find that it will provide a great wash/rinse cycle while remaining gentle on the surface.

POWER HOUSE is a unique blend of specialty surfactants and alkalis specifically formulated for the Professional Exterior House Washing Industry. It acts by first wetting and chelating pollutants and then holding them in suspension until the surface is thoroughly rinsed. POWER HOUSE is less aggressive on surface and vegetation than typical cleaners used in this field but will achieve superior cleaning results.

PART #	NOTES:	NET PRICE
ZPPH	1 EACH - 55 GALLON DRUM KIT	\$104.40
'Mix & Match' any 6 Drum Kits and WE PAY THE FREIGHT!		
Freight Program is only available in the continental USA CANADA & all others receive a \$15.00 per box freight allowance.		
PH5	8 GALLON POWER PACK KIT	\$20.00

Removing Gutter Streaks & HEAVY OXIDATION

RIPPER

Are you having trouble removing those 'nasty' Black Streaks on Gutters & Surface Oxidation? **NOT ANY MORE!**

Our House Wash Collection offers a rich assortment of job matched cleaning products that are uniquely EnviroSpec. RIPPER is just one in that collection that has been making the Exterior House Washing Professional's job so much easier for so many years. To professionals, the real beauty to any of the EnviroSpec performance products is how fast, how effective and how safe they are to use.

RIPPER, developed specifically for gutter streaks & oxidation removal, utilizes several blends of high-performance solvents and specially blended surfactants to deliver optimum efficiency. Knowing that no two gutters will clean alike, EnviroSpec has incorporated into RIPPER a variety of solvent blends that will work independently on the specific pollutant that has created the streak. One of these unique solvents will attack and eliminate the problem.

Of all the questions that have been thrown at us about house washing - the question of how to safely remove gutter streaks is by far the most frequent. We know that solvents are the only products that will safely remove gutter streaks and RIPPER has more than twice the solvent content than most cleaning products in our industry.

After its introduction into the industry in 1987 RIPPER soon became the envy of many companies who are in the business of manufacturing products for such a demanding industry. Many of those companies sell sodium or potassium hydroxide base products to tackle the gutter streak problem and the unsuspecting contractor buys them not knowing that what they are actually buying are paint strippers. RIPPER is a more effective and much safer way to eliminate the gutter streak & oxidation problem.

PART #	NOTES:	NET PRICE
ZPRIP	1 EACH - 55 GALLON DRUM KIT	\$164.84
'Mix & Match' any 6 Drum Kits and WE PAY THE FREIGHT!		
Freight Program is only available in the continental USA CANADA & all others receive a \$15.00 per box freight allowance.		
RIP5	8 GALLON POWER PACK KIT	\$20.00

Mix & Match any FREE FREIGHT Product to achieve the Buy 6 Requirement

Neutralizes, Brightens & Repairs Unpainted Wood

DECK & SHAKE BRIGHTENER

Un-neutralized High pH Detergents Destroy Wood

High 'pH beds' of detergents, especially sodium or potassium hydroxide, shorten the life expectancy of wood. When those products are used & not neutralized wood surfaces deteriorate fast.

The Deck Restoration Industry has grown considerably in recent years. As is the case when most great ideas are conceived - experts seem to blossom overnight as they have done here. This is not always a good thing.

In the Professional Mobile Wash Industry contractors quite often find themselves in the 'clutches' of many companies with so-called 'revolutionary' cleaning products that are merely extremely high pH detergents of which most are either sodium or potassium hydroxide based. These are great products but not for this industry. The hydroxide family of products are extremely effective in the drain cleaning and exhaust hood cleaning industries but certainly not wood cleaning. When used for wood cleaning they immediately start breaking down wood fibers.

More often than not this idea of using an excessively strong alkali detergent 'bed' has been introduced to kill mold and mildew. We have a product, RESTORE, that will do this without harming the wood but even if RESTORE is not the product of choice a very diluted solution of bleach would be a much better choice than high pH detergents.

Deck & Shake Brightener is a product that will do 2 things. First it will brighten weathered wood and revive it's natural color. For years this product has been a favorite among furniture craftsmen who occasionally find themselves in a situation where a dark or stained spot needs to be blended back in to match the rest of the wood. Second it can be used as the necessary "bandage" when contractors insist on using these strong detergents and the wood has darkened as a result. Or they have to follow behind another contractor who has darkened the wood and doesn't know how to fix it. Deck & Shake Brightener quickly starts reversing this action upon contact. Typically, the darkened surface will be back to normal in 1-4 days.

PART #	NOTES:	NET PRICE
ZPDSB40	1 EACH - 55 GALLON DRUM KIT	\$71.07

'Mix & Match' any 6 Drum Kits and WE PAY THE FREIGHT!

Freight Program is only available in the continental USA CANADA & all others receive a \$15.00 per box freight allowance.

DSB5	5 GALLON POWER PACK KIT	\$20.00
------	-------------------------	---------

Mildew Retardant & Surface Protector

PLEX-MASTER

EXTERIOR SURFACE SEALANT with MILDEW FORMATION RETARDANT

Plex-Master is a blend of silicone & silicone hardener, polymer and mildew retardant that will enhance the appearance of Vinyl and Aluminum Siding, Painted Wood and Metal surfaces after cleaning. Plex-Master is also an excellent product that will eliminate or substantially reduce the reformation of mold and mildew on all surfaces.

Plex-Master provides a distinctive edge that will separate the Professional Contract Cleaner from the "Splash 'N Dash" house washer. For just pennies per job the contract cleaner can provide the homeowner with a 'cleaner clean' and a 'brighter shine' that will last much longer than that of their closest competitor.

When you explain the advantages of using environment friendly products that will leave the soil exactly the way you found it and the added benefit of the Plex-Master application you have virtually left your competitors in the 'dust (dirt)'. With the addition of this product to your sales presentation you will be washing houses from \$400.00 and up even though your competitor quoted them \$79.95. This is a fact that has been proven time and time again.

Mildew, which will form on virtually anything, will be much easier to remove when the surface has been coated with Plex-Master. In most cases the homeowner will be able to keep the surface looking 'alive and free' of mildew with an occasional rinse down using a standard garden hose. Another great feature of Plex-Master is that once applied and rinsed before it has been allowed to dry, the windows will be 'squeaky' clean.

Very quickly downstream Plex-Master 'on' and 'rinse off'. Work in small enough areas so the product can be rinsed before it dries. Typically a 2000 square foot home will require approximately 5 gallons of the Plex-Master mix and the application and rinse process will take about 15 minutes.

PART #	NOTES:	NET PRICE
ZLPLE5	1 EACH - 55 GALLON DRUM KIT	\$65.88

'Mix & Match' any 6 Drum Kits and WE PAY THE FREIGHT!

Freight Program is only available in the continental USA CANADA & all others receive a \$15.00 per box freight allowance.

1 EACH 5 GALLONS MAKES 55 GALLONS OF CONCENTRATE		
--	--	--

Mix & Match any FREE FREIGHT Product to achieve the Buy 6 Requirement

The #1 Selling Concrete Cleaning Formula

POWER STROKE

Specifically developed for - FLAT SURFACE CONCRETE CLEANING

FOR PARKING GARAGES, STADIUMS, STRIP MALLS, SHOPPING PLAZAS, RUNWAYS, DRIVEWAYS, PATIOS, DUMPSTER AREAS, SWIMMING POOLS & BANK DRIVE-THRUS

"Power Stroke" has successfully replaced the harsh caustics that have been being used for years. The science behind Power Stroke has made it the Professionals First Choice.

Contains: CONCRETE BRIGHTENING AGENTS

Power Stroke is the highest non-caustic detergent concentration available in the industry.

Power Stroke has been specifically formulated for heavy-duty oil/grease removal for untreated concrete. Unlike the caustics typically used in this industry Power Stroke is much more user and surface friendly when it comes to over spray. You will find Power Stroke cleans much 'quicker' than caustics and acids due to it's excellent wetting, rinsing and emulsification properties and SuperFlo Polymer Complex System.

The general rule of thumb in detergent formulation is as follows: Approximately 1 gallon of water will hold approximately 1 pound of powder before separation begins. If your product begins to separate using this calculation, more often than not, your product has been camouflaged with what is known in our industry as fillers. Fillers provide little to no value to the products integrity. They are used primarily to add weight and increase the bottom line profit for the manufacturer. A typical filler would be Soda Ash. Using the 1 pound per 1 gallon rule you can see the potency of Power Stroke when you consider that we are able to thoroughly dissolve up to 2.5 pounds of Power Stroke into 1 gallon of water without separation. To our knowledge - no other company can make this claim. The advantage of these concentration levels are two fold: 1) the contractor is now able to clean substrates that normally require the use of caustic cleaners and 2) work faster and safer which increases your bottom line.

PART #	NOTES:	NET PRICE
ZPPOW	1 EACH - 55 GALLON DRUM KIT	\$175.82
'Mix & Match' any 6 Drum Kits and WE PAY THE FREIGHT!		
Freight Program is only available in the continental USA CANADA & all others receive a \$15.00 per box freight allowance.		
PSS	5 GALLON POWER PACK KIT	\$20.00

Remove Rust Stain From Concrete

RUST-AWAY

Specifically Formulated to
REMOVE WELL-WATER RUST STAINS FROM CONCRETE

Spray-on! Rinse-off! No Scrubbing Necessary!

***If you work or live in Florida there are two things you must have...
...a bathing suit and a box of Rust-Away!***

RUST-A-WAY crystals are a unique blend of acids and surfactants which remove well-water rust stains from concrete surfaces.

Spray dissolved solution onto surfaces...
...have a cup of coffee and rinse off.

Not for use on Brick containing iron oxide pigments.

Run a test pattern in an
inconspicuous area if you are not sure.



PART #	NOTES:	NET PRICE
ZPRUS40	1 EACH - 55 GALLON DRUM KIT	\$71.43
'Mix & Match' any 6 Drum Kits and WE PAY THE FREIGHT!		
Freight Program is only available in the continental USA CANADA & all others receive a \$15.00 per box freight allowance.		
RUS5	5 GALLON POWER PACK KIT	\$20.00

THE ONLY NON-CAUSTIC EXHAUST HOOD CLEANER

HOOD-PRO

The Industry's First and Best Non-Caustic RESTAURANT EXHAUST HOOD CLEANER

Until now Professionals have always had to rely on corrosives for the real tough hood cleaning jobs but not anymore! Hood Pro has revolutionized the industry by providing the contractor with a product that cleans as quick and effective as the 'hottest' hydroxide products in the industry while leaving him completely 'scare free' and with hair still on his arms when the job is complete. Only a Professional Exhaust Hood Contractor can fully appreciate that statement.

EnviroSpec's HOOD PRO product is the non-caustic workhorse of the professional exhaust hood cleaning industry. Known for its consistent high performance, this powerful grease dissolving formula is being used more and more by the professionals who know and understand the disadvantages of using sodium or potassium hydroxide products. The "power" from Hood-Pro comes mainly from a wide variety of special 'ion' charged surfactants not commonly found in the detergent formulary industry. Coupled with a unique "builder" base, HOOD-PRO exhibits unbelievable pH stability and excellent foaming characteristics.

HOOD PRO offers excellent and economical grease dissolving, foaming, wetting, emulsification and biodegradability needed for today's specialized contractor. HOOD PRO is 100% active and highly concentrated. For example; the 'hottest' hydroxide products consist mainly of 50 pounds of powder to 50 gallons of water. The finished HOOD-PRO product will yield 55 gallons which is compounded from 80 pounds of the finest builders and performance driven surfactants in the industry

HOOD PRO will respond to your most difficult cleaning project with ease and provide you with an environment which is much safer to humans and less damaging to the surface.

PART #	NOTES:	NET PRICE
ZPHP	1 EACH - 55 GALLON DRUM KIT	\$181.32
'Mix & Match' any 6 Drum Kits and WE PAY THE FREIGHT!		
Freight Program is only available in the continental USA CANADA & all others receive a \$15.00 per box freight allowance.		
HP5	5 GALLON POWER PACK KIT	\$20.00

Exhaust Carbons Explode from the Surface!

'OCB' EMULSIFIER

"OIL EATING" SUPER SOLVENT-SURFACTANT

for those 'nasty' Truck Fleets that are loaded with exhaust carbon.

**'OCB' Emulsifier can be added to any
Drum Pack of EnviroSpec Detergent
in concentration levels of 1 Gallon to 55 Gallons.**

Ask any Professional Mobile Washer who washes trucks and they will tell you that not a 'shift' goes by without running into at least one account that is loaded with exhaust carbon on the 'stack side' of the trailer that seems to take forever to clean and when you think you are through - the job still looks terrible!

Add 1 Gallon of 'OCB' Emulsifier
and watch the carbon & grease
explode off the surface!

PART #	NOTES:	NET PRICE
ZLOIL	1 Gallon Container	\$32.91
1 Gallon Activates & Energizes 55 Gallons of Detergent		

Mix & Match any FREE FREIGHT Product to achieve the Buy 6 Requirement

Make Your Own CAUSTIC Exhaust Hood Cleaner

PERFORMANCE BUILDER

WAIT! DON'T BUY ANY MORE CAUSTIC HOOD CLEANERS

if you do you are wasting even more money!

Personally speaking I think one of the biggest 'scams' perpetrated on the Professional Mobile Wash Industry is trying to make them think that there is a lot of 'rocket science' that goes into producing high performance, caustic exhaust hood cleaners. There isn't and if you insist on purchasing those type of products - well then - you are just wasting a lot of money because anyone can make them.

Simply purchase a drum of 85% Potassium Hydroxide and add one gallon of
PERFORMANCE BUILDER PLUS

Sodium Hydroxide and Potassium Hydroxide Exhaust Hood Cleaners and Paint Strippers (same thing) are nothing but 1 gallon of surfactant added to the drum and stirred in. Nothing more - *nothing less*. The secret is this - because of the aggressiveness of these two raw materials there are only a couple of surfactants that are stable in the solution for any period of time and they are not cheap. Because of the cost of this family of surfactants many manufacturers rely on a nine mole surfactant such as that found in typical detergents and slap a label on it and out the door it goes. The trouble here is that by the time you get the product the surfactant has been overwhelmed by the hydroxide to a point where it has exhausted it's ability to perform. Performance Builder Plus is a blend of high yield, caustic stable surfactants & emulsifiers that will hold up indefinitely and help to 'crank up' the horsepower of the raw material.

Next time you decide to buy a caustic cleaner order up a gallon of Performance Builder Plus. Then look in your yellow pages for your local chemical supplier. If you can't find one call Univar at 800-233-0633 or <http://www.univarusa.com> or Brentag Mid South at 800-289-4020 or <http://www.pbschemical.com> for their location nearest you.

A premium caustic exhaust hood cleaner would be one where 50 pounds of sodium hydroxide beads are mixed with 55 gallons of water along with one gallon of Performance Builder Plus. Exercise caution when mixing sodium hydroxide beads with water. Add very slowly otherwise there can be a violent reaction where the product will blow back on you. After the beads have been added stir in the Performance Builder Plus. If you use Potassium Hydroxide you will purchase that in a 85% liquid form. Typically a manufacturer will make 4 drums out of 1 drum of the 85% solution. In this case you will need 4 each 2.5 gallon containers of Performance Builder Plus. EXERCISE CAUTION when working with any chemical product. Read and understand the MSDS and all safety information about the products being handled. Wear protective clothing and safety glasses. Do not allow any unprotected person or animal around the mixing area. Clean up when done.

PART #	NOTES:	NET PRICE
ZLPBC	1 EACH - 2.5 GAL CONTAINER	\$71.37
ZLPBC55	55 GALLON DRUM	\$1263.74
ADD 1 EA 2.5 GAL. BOTTLE TO 55 GALLON DRUM		

QUICK RINSE ADDITIVE

SPEED-X-777

Not making as much money as you thought you would?

Have you stopped to consider that 70% of your cleaning time is lost in the RINSE rather than WASHING?

Don't believe it? The next time you go to the job site time yourself. How long does it take to apply the soap and how long does it take to make absolutely sure that all the "soap" is rinsed free? *You are in for a shock!*

Cut your rinse time as much as 80% with Speed-X-777

Plus You'll Save That Precious Water!



Add 1 Gallon to 55 Gallons of detergent.
(enough for 275 Gallons)

PART #	NOTES:	NET PRICE
ZLSPE5	1 EACH - 5 GALLON PAIL	\$54.89

Mix & Match any FREE FREIGHT Product to achieve the Buy 6 Requirement

Sodium & Potassium Hydroxide FREE Deck & Shake Stripper

STRIPT-EASE

The Fastest Acting, Safest Deck Stripper in the Industry.

Does not contain harmful hydroxides that shortens deck life.

Simply spray 'STRIPT-ease' on and let it sit for 15 minutes and power wash the stain away.

'STRIPT-ease' contains a unique blend of surfactants and emulsifying solvents that attack and breakdown the stain allowing for a fast attack and flush product.

'STRIPT-ease' is packaged in a 55 gallon drum pack which consist of 50 pounds of a powder and solvent blend. Simply add your own water to produce a product that is superior and safer than anything you have ever used.

PART #	NOTES:	NET PRICE
ZPSTR	1 EACH - 55 GALLON DRUM KIT	\$109.89
'Mix & Match' any 6 Drum Kits and WE PAY THE FREIGHT!		
Freight Program is only available in the continental USA CANADA & all others receive a \$15.00 per box freight allowance.		
NO POWER PACKS AVAILABLE		

GLASS DE-ETCH

FOR ACID DAMAGED GLASS!

Jewelers use a lesser grade of this compound to polish out scratches on expensive crystal.

Glass De-Etch is a Rare Earth Glass/Crystal Polishing Compound to be used when severe acid damaged has occurred to any glass.

USE INSTRUCTIONS:

Mix with water to the consistency of pancake batter and wipe on windshield. Using a electric buffer with a low pile polishing pad buff briskly into the surface. Work in small areas.

A high stock removal rate, which is partially due to the narrow particle distribution resulting in a low percentage of fines, leaves a clear, bright finish.

Physical Characteristics: Color: Pale Pink
Composition: REO Content - 76%
Average Particle Size: 3.4 Microns

PART #	NOTES:	PRICE EA.
ZPGDE	1 EACH - 1 POUND	\$32.91

Enough for 10 Windshields

SCUM BUSTER

OOOPS!

**Did you let soap dry on the glass?
Yes Scum Buster Really Works!**

Scum Buster is manufactured from the world's finest Rare Earth Glass Polishing Compounds.

USE INSTRUCTIONS:

Mix with water to the consistency of warm syrup. Wipe or paint onto glass and briskly polish surface.

PHYSICAL CHARACTERISTICS:

Color: Pale Pink
Composition: REO Content - 76%
Average Particle Size: 3.4 Microns
pH Factor: 6.7 - 8.0
Trapped Bulk Density: 1.39 grams
Suspension Treated
Insoluble in Water

PART #	NOTES:	NET PRICE
ZPSB	1 EACH - 5 POUNDS	\$32.91

Enough for all the Glass in 2-3 Houses

Mix & Match any FREE FREIGHT Product to achieve the Buy 6 Requirement

The Incredible Power of Zoloid Cross-Linked Surfactants

Z'GREASER

THE INDUSTRY'S MOST POWERFUL DEGREASING FORMULA

z'Greaser is the most powerful non-caustic formula in the degreasing chemical industry. Over 40 pounds of powder plus liquid activators are blended together to make 55 Gallons of liquid concentrate.

So, if you find yourself in a real 'bind' over removing oils and grease you will be amazed at what z'Greaser will 'cut.'

In general, z'Greaser was formulated to disrupt the surface membrane of grease in order to first free and then solubilize membrane-bound pollutants while, at the same time, holding those pollutants in solution and not allowing them to redeposit themselves elsewhere on the surface prior to rinsing.

Because of its wide range of a unique Zoloid Surfactant which is produced by EnviroSpec, z'Greaser can be utilized in a wide variety of cleaning applications. We have tested this product extensively in the truck washing industry and found that at a final product to surface dilution level of 225 parts water to 1 part product, z'Greaser produced the best results in 98% of our test models. In the heavy equipment degreasing industry 90 parts water to 1 part z'Greaser proved to be the best dilution rate.

Although expensive on a per unit basis, when you consider the unlimited cleaning projects that can be performed by z'Greaser at these phenomenal dilution rates you can readily see that this is really one of the most cost effective products on the market. It is not uncommon to have 1 drum of z'Greaser Concentrate to equal 5 drums of what is presently being sold to the Professional Mobile Wash Industry by other manufacturers.

PART #	NOTES:	NET PRICE
ZPZG	1 EACH - 55 GALLON DRUM KIT	\$164.84
'Mix & Match' any 6 Drum Kits and WE PAY THE FREIGHT!		
Freight Program is only available in the continental USA CANADA & all others receive a \$15.00 per box freight allowance.		
ZG5	8 GALLON POWER PACK KIT	\$20.00

NOTES:	NOTES:

WE SHIP FROM THE CLOSEST WAREHOUSE - HOMERVILLE, GA or MILWAUKEE, WI

EnviroSpec
751 MLK Highway
Homerville, GA 31634

PRSR STD
U.S. POSTAGE
PAID
PPCO



Cleaning Products from the future
with today's environment in mind-

Serving the
INDUSTRIAL CLEANING INDUSTRY
Since 1972

1-800-346-4876

...a sunrise on Jekyll Island, GA