

### FEATURES

- Solid ceramic plungers
- Standard SAE J609 gasoline mounting flange for up to 13 hp engines
- Forged brass manifold with an exclusive lifetime warranty and 4:1 hydrostatic rating
- Die-cast, anodized aluminum, oil-bath crankcase
- Premium roller bearing
- Unitized stainless steel inlet and discharge valves
- Available in “L” left-handed versions

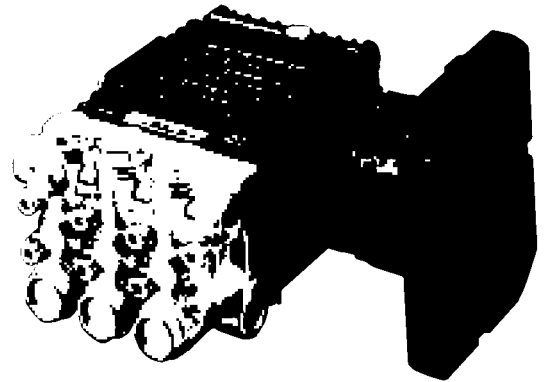

### SPECIFICATIONS

Pump Model	EZ3030G34	EZ3035G	EZ3040G	EZ3045G
Maximum Volume	3.0 GPM	3.5 GPM	4.0 GPM	4.6 GPM
Maximum Discharge Pressure	3000 PSI			
Maximum Pump Speed	3400 RPM			
Maximum Inlet Pressure	125 PSI			
Maximum Inlet Vacuum	3 ft. water (2.6 in. Hg)			
Bore	.591 in. / 15 mm			
Stroke (in./mm)	.287 / 7.3	.335 / 8.5	.374 / 9.5	.433 / 11
Crankcase Oil Capacity	14.0 oz.			
Maximum Fluid Temperature	165°F			
Inlet Port Thread	1/2-14 BSPP-F			
Discharge Port Thread	3/8-19 BSPP-F			
Hollow Shaft I.D.	1.0 in. / 25.4 mm			
Weight	19.1 lbs.			
Dimensions	8.8 x 9.7 x 6.5 in.			

### DIMENSIONAL DRAWING

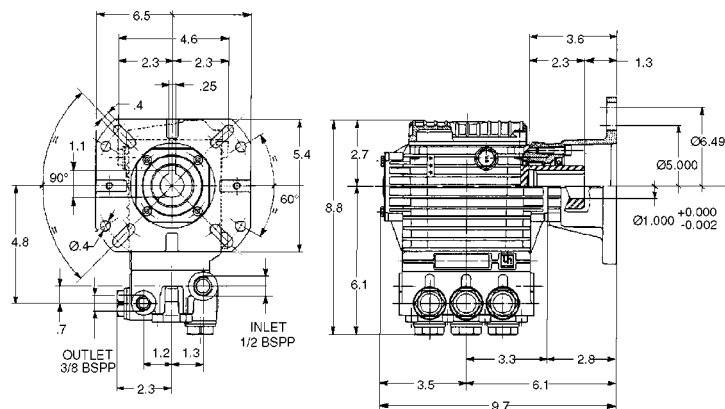

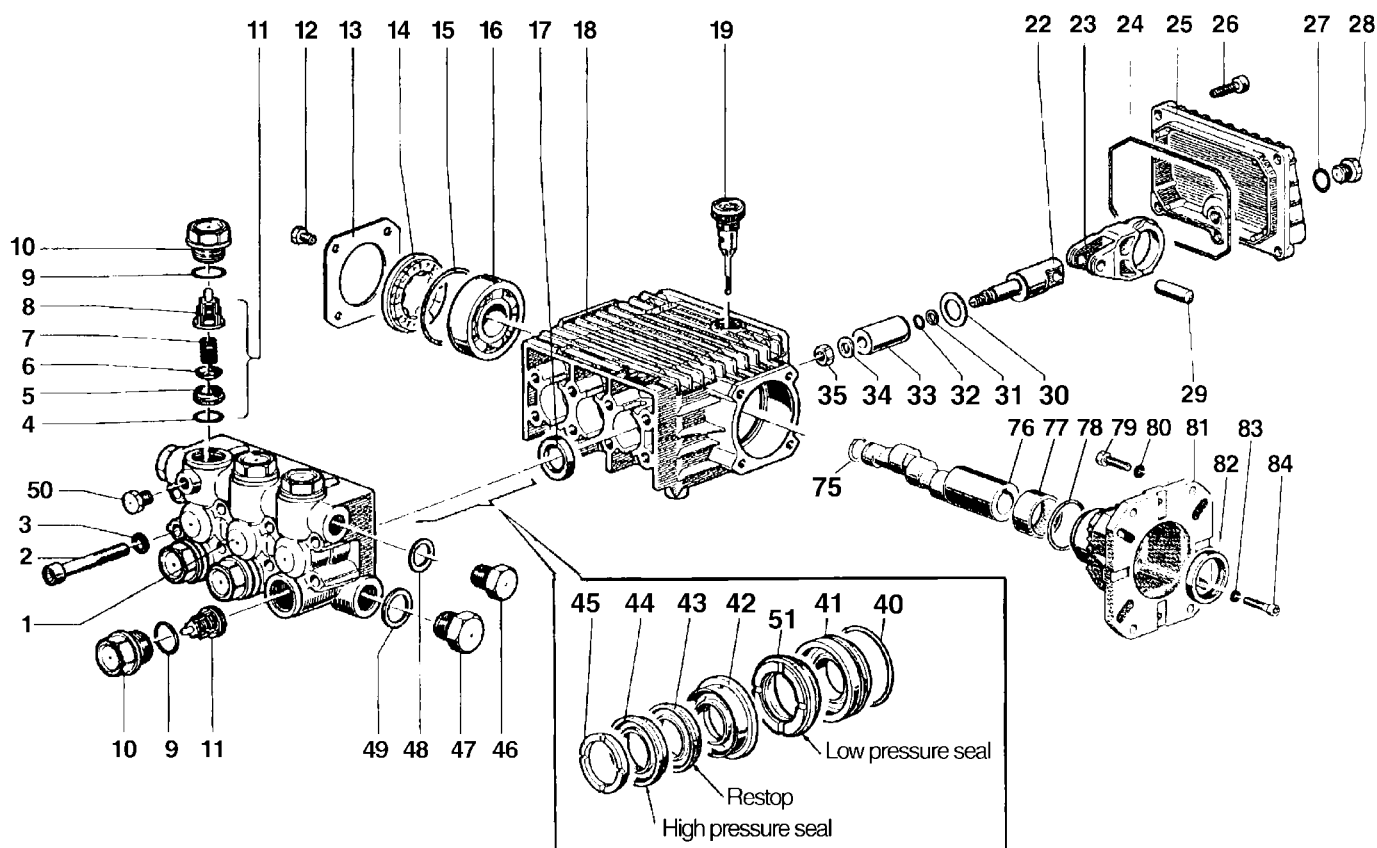

## PARTS LIST

Item	Part No.	Description	Kit No.	Qty.	Item	Part No.	Description	Kit No.	Qty.	Item	Part No.	Description	Kit No.	Qty.
1.	44.1200.41	Manifold (15 mm)		1	23.	44.0300.22	Connecting Rod		3	47.	98.2176.00	Cap Screw		1
2.	99.3175.00	Screw		8	24.	90.3920.00	O-Ring		1	48.	96.7380.00	Washer		1
3.	96.7014.00	Washer		8	25.	44.1600.22	Rear Cover		1	49.	96.7514.00	Washer		1
4.	90.3841.00	O-Ring	123	6	26.	99.1837.00	Screw		5	50.	98.1966.00	Cap Screw		1
5.	36.2003.66	Valve Seat	123	6	27.	90.3585.00	O-Ring		1	51.	90.2617.00	Seal, Low Press.	88, 130	3
6.	36.2001.76	Valve	123	6	28.	98.2041.00	Cap Screw		1	75.	90.0635.00	Retaining Ring		1
7.	94.7376.00	Spring	123	6	29.	97.7340.00	Pin		3	76.	44.0212.65	Crankshaft (EZ3045G)		1
8.	36.2025.51	Valve Cage	123	6	30.	96.7350.00	Washer		3	44.0220.65	Crankshaft (EZ3035G)		1	
9.	90.3847.00	O-Ring	124	6	31.	90.5022.00	Anti-Extrusion Ring		3	44.0209.65	Crankshaft (EZ3040G)		1	
10.	98.2226.00	Cap Screw	124	6	32.	90.3572.00	O-Ring		3	44.0218.65	Crankshaft (EZ3030G34)		1	
11.	36.7115.01	Valve Assembly	123	6	33.	52.0400.09	Plunger, 15 mm		3	77.	91.8568.00	Roller Bearing		1
12.	99.1807.00	Screw		4	34.	96.7008.00	Washer		3	78.	90.4097.00	O-Ring		1
13.	50.1500.74	Bearing Cover		1	35.	92.2216.00	Nut		3	79.	99.2755.00	Screw, 5/16x1		4
14.	44.2118.01	Spacer		1	40.	90.3612.00	O-Ring	125, 130	3	99.3345.00	Screw, 3/8x1		4	
15.	90.4097.00	O-Ring		1	41.	44.0800.70	Packing Retainer	125, 130	3	80.	96.7020.00	Washer, Ø8 mm		4
16.	91.8328.00	Ball Bearing		1	42.	52.2166.70	Intermediate Ring	89, 130	3	96.7104.00	Washer, Ø10 mm		4	
17.	90.1614.00	Oil Seal	23	3	43.	90.2622.00	Packing	88, 130	3	81.	10.0518.22	Gas Flange		1
18.	44.0100.22	Crankcase		1	44.	90.2620.00	Packing	88, 130	3	82.	90.1690.00	Oil Seal		1
19.	98.2103.00	Oil Dip Stick		1	45.	51.1000.51	Head Ring	90, 130	3	83.	96.6938.00	Washer		4
22.	44.0500.66	Plunger Guide		3	46.	98.2100.00	Cap Screw		1	84.	99.1912.00	Screw		4

## REPAIR KITS

KIT NO.	23	88	89	90	123	124	125	130
ITEM NO.s INCLUDED IN KIT	17	43, 44, 51	42	45	4, 5, 6, 7, 8, (11)	9, 10	40, 41	40, 41, 42, 43, 44, 45, 51
NUMBER OF ASSEMBLIES IN KIT	3	3/6	3	6	6	6	3	1
NUMBER OF CYLINDERS KIT WILL SERVICE	3	3	3	3	3	3	3	1

## TORQUE SPECS\*

Position	Ft.-lbs.	N-M
2	14.7	20
10	73.7	100
12	7.3	10
26	7.3	10
28	14.7	20
35	11.0	15
46	29.4	40
47	29.4	40
50	9.6	13
79	14.7	20
84	7.3	10

\*Decrease torque by 20% if threads are lubricated.