

FEATURES

- Forged brass manifold with an exclusive lifetime warranty
- Die-cast, anodized aluminum, oil-bath crankcase
- Solid ceramic plungers with continuously lubricated packings
- The original InterPump unitized stainless steel K01 inlet and outlet valves
- Standard 24 mm solid shaft for pulley mounting
- Flex coupling and bell housing available for direct drive
- Ideal for all general cleaning/washing applications
- Available in “L” left-handed versions



SPECIFICATIONS

Pump Model	T991	T911	T9951	T9971	TT9351	TT9441
Maximum Volume	4.0 (3.5) GPM	3.5 GPM	3.5 GPM	4.0 GPM	3.5 GPM	4.4 GPM
Maximum Discharge Pressure	1100 (1500) PSI	1400 PSI	1500 PSI	2000 PSI	2500 PSI	
Maximum Pump Speed	1750 (1450) RPM	1450 RPM	1750 RPM		3400 RPM	
Maximum Inlet Pressure	125 PSI					
Maximum Inlet Vacuum	9 ft. water (7.9 in. Hg)					
Bore	.787 in. / 20 mm				.591 in. / 15 mm	
Stroke (in./mm)	.394 / 10		.335 / 8.5	.394 / 10		.335 / 8.5
Crankcase Oil Capacity	15.2 oz.					
Maximum Fluid Temperature	165°F					
Inlet Port Thread	1/2-14 BSPP-F					
Discharge Port Thread	3/8-19 BSPP-F					
Shaft Diameter	.945 in. / 24 mm					
Weight	19 lbs.	15 lbs.	19 lbs.		18.7 lbs.	
Dimensions	9.3 x 8.3 x 5.4 in.					

DIMENSIONAL DRAWING

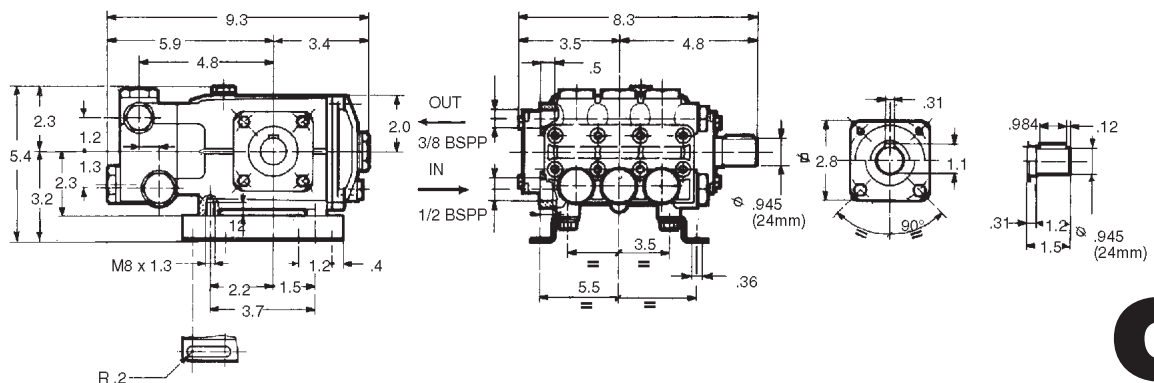

T Series 50 – Solid Shaft

GENERAL PUMP A member of the Interpump Group

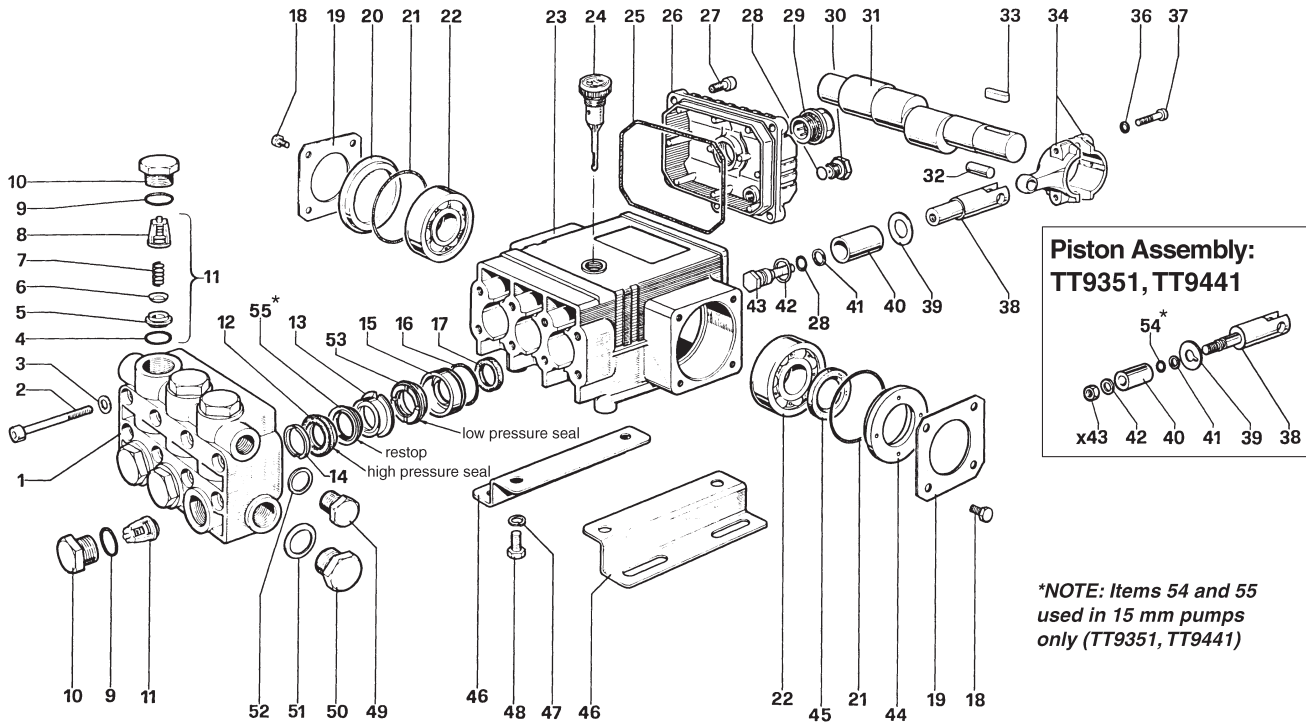

PARTS LIST

ITEM	PART NO.	DESCRIPTION	KIT	QTY.	ITEM	PART NO.	DESCRIPTION	KIT	QTY.	ITEM	PART NO.	DESCRIPTION	KIT	QTY.
1.	50.1207.41	Manifold, Brass		1	20.	50.2116.51	Spacer		2	39.	96.7286.00	Washer	6	3
	50.1205.41	Manifold, Brass (TT9351, TT9441)		1	21.	90.4097.00	O-Ring, 2.188 x .139		1		96.7070.00	Washer (TT9351, TT9441)		
	50.1200.22	Manifold, Aluminum (T911)		1	22.	91.8329.00	Ball Bearing		2	40.	50.0404.09	Plunger (20 mm)		3
2.	99.3175.00	Screw		8	23.	50.0104.22	Crankcase		1		52.0400.09	Plunger (15 mm) (TT9351, TT9441)		
3.	96.7014.00	Washer		8	24.	98.2103.00	Oil Dip Stick		1	41.	90.5067.00	Back-up Ring	6	3
4.	90.3841.00	O-Ring, .675 x .103	1	6	25.	90.3920.00	O-Ring, 3.987 x .103		1		90.5022.00	Back-up Ring (TT9351, TT9441)		
5.	36.2003.66	Valve Seat	1	6	26.	50.1600.22	Cover		1	42.	96.7280.00	Washer	6	3
6.	36.2001.76	Valve Plate	1	6	27.	99.1837.00	Screw		5		96.7008.00	Washer (TT9351, TT9441)		
7.	94.7376.00	Spring	1	6	28.	90.3585.00	O-Ring, .426 x .070	6	4	43.	47.2195.66	Plunger Screw	6	3
8.	36.2002.51	Valve Guide	1	6	29.	97.5968.00	Oil Level Indicator		1	x43.	92.2216.00	Nut, M8, SS		3
9.	90.3847.00	O-Ring, .797 x .103	4	6	30.	98.2041.00	Cap		1	44.	50.2115.51	Spacer		1
10.	98.2220.00	Cap	4	6	31.	50.0218.35	Crankshaft (T991, T911)		1	45.	90.1634.00	Oil Seal		1
11.	36.7032.01	Valve Assembly	1	6		50.0219.35	Crankshaft (T9951)			46.	50.2000.74	Pump Feet		2
12.	90.2703.00	Packings	19, 27	3		50.0201.35	Crankshaft (T9971, TT9441)			47.	96.7016.00	Washer		4
	90.2620.00	(TT9351, TT9441)	88, 92			50.0205.35	Crankshaft (TT9351)			48.	99.3037.00	Screw		4
13.	50.2166.70	Intermediate Ring	20, 27	3	32.	97.7330.00	Wrist Pin		3	49.	98.2100.00	Cap		1
	52.2166.70	(TT9351, TT9441)	89, 92		33.	640048	Key		1	50.	98.2176.00	Cap		1
14.	50.1000.51	Head Ring	21, 27	3	34.	50.0300.01	Connecting Rod, Aluminum		3	51.	96.7514.00	Washer		1
	51.1000.51	(TT9351, TT9441)	90, 92			50.0303.01	Connecting Rod (T9971)			52.	96.7380.00	Washer		1
15.	50.0805.70	Packing Retainer	22, 27	3	36.	96.6939.00	Washer		6	53.	90.2698.00	Packing, Low Press.	19, 27	3
	52.0805.70	(TT9351, TT9441)	91, 92		37.	99.1927.00	Screw		6		90.2617.00	(TT9351, TT9441)	88, 92	
16.	90.3612.00	O-Ring, 1.239 x .070	22, 27	3	38.	50.0501.56	Plunger Guide		3	54.	90.3572.00	O-Ring, .208" x .070"		3
17.	90.1614.00	Oil Seal	23	3		52.0500.56	Plunger Guide (TT9351, TT9441)			55.	90.2622.00	Restop Ring	88, 92	3
18.	99.1807.00	Screw		8										
19.	50.1500.74	Crankcase Cover		2										

REPAIR KITS

KIT NO.	1	4	6	19 or 88	20 or 89	21 or 90	22 or 91	23	27 or 92
ITEM NO.s INCLUDED IN KIT	4, 5, 6, 7, 8 (11)	9, 10	28, 39, 41, 42, 43	12, 53, 55* *15mm only	13	14	15, 16	17	12, 13, 14, 15, 16, 53, 55* *15mm only
NUMBER OF ASSEMBLIES IN KIT	6	6	3	3	3	6	3	3	1
NUMBER OF CYLINDERS KIT WILL SERVICE	3	3	3	3	3	3	3	3	1

TORQUE SPECS*

Position	Ft.-lbs.
2	14.7
10	73.7
18	7.3
27	7.3
29	13.2
30	14.7
37	8.8
43	14.7
48	14.7
49	29.4
50	29.4

*Decrease torque by 20% if threads are lubricated.

