

HI-TECH 501 GUN



\$19.95

NEW
for '08

Permissible Rating
4,500 PSI - 300°F
Easy Access
Repair Kit Panel
PART #
2210-501

#CERAMIC932
Repair Kit
(Ceramic Ball Only)

REMEMBER!
WHEN YOU SEE THE

5%

this means that you will save and additional
5% if you e-Mail or Fax your order.

5%

\$26.95

HI-TECH 2002
11 GPM - 4660 PSI - 320° F
#HT2002
#CERAMIC1332
Repair Kit (Ceramic Ball Only)

5%

\$22.73

HI-TECH 5000
9 GPM - 5000 PSI - 300° F
#2210-500
#CERAMIC516
Repair Kit (Ceramic Ball Only)

Safety YELLOW

\$27.95

ARROW LINE AL-35
8 GPM - 5000 PSI - 300° F
#AL35
#CERAMIC516
Repair Kit (Ceramic Ball Only)

5%

\$47.95

HI-TECH 4100
13 GPM - 4100 PSI - 320° F
#2210-041
#CERAMIC1332
Repair Kit (Ceramic Ball Only)

K-7 UNLOADER

2.1-3.0 GPM #1510-070
3.1-4.2 GPM #1510-071
4.3-6.6 GPM #1510-072
6.7-11 GPM #1510-073

5%
Sale Price
\$77.00
Reg Price \$147.95

GREEN SPRING 2140 UNLOADER
Reg Price \$208.95
Sale Price
\$79.95
P/N 1510-128G

AL-607 UNLOADER
Reg Price \$86.95
Sale Price
\$39.95
P/N 1599-101

5%

UNLOADER MOUNTING BLOCK
Reg Price \$29.95
Sale Price
\$13.41

#1499-990 3/8 x 3/8
#1499-991 3/8 x 1/2
#1499-992 1/2 x 1/2



Dual Nozzle Holder
NOT Made in China!
Another EnviroSpec Exclusive!

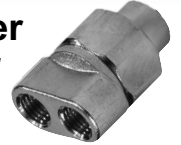

5%

Part Number	Description
2410-350	Holder with Stainless Steel Ball
2410-353	2410-350 With HP Swivel
2410-550	Holder with Ceramic Ball
2410-553	2410-550 with HP Swivel

- 12 GPM
- 3,500 PSI
- Up to 190 degrees
- 1/4" inlet from lance
- 2 ea. 1/4" outlets accommodates 2 nozzles
- Rotate lance to change to soap nozzle

'350'
\$14.18
'353'
\$34.83
'550'
\$17.44
'553'
\$38.95

Are you going to take advantage of our poor math?

13 HP Honda..... + Industrial Cart = The Industry's Best Buy!

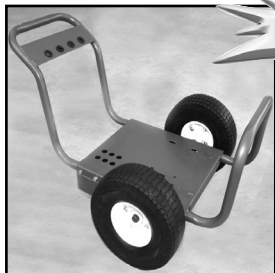

That's Right!
A \$926.00 VALUE
for the Low, Low Price of...

\$796.87 + \$129.95 = \$649.95

"QC" NOZZLE
Reg Price \$12.95

Sale Price
\$2.78

Sizes 3.0 thru 6.5
Use 'LQ'-????



LASERJET

1/4" MEG NOZZLE
Reg Price \$12.95

Sale Price
\$2.78

Sizes 3.0 thru 6.5
Use 'LM'-????



LASERJET

Soap For Hope

is a John & Shelley Allison Charity made possible by EnviroSpec



What do you really know about EnviroSpec?

Meet Suzie who inspired the Allison's to build Suzie's Friends Animal Shelter



Want to see it?
Go to www.suziesfriends.org and 'click' on the video link.
You WILL BE touched!

EnviroSpec Is the Industry's Price Leader... AGAIN!

Just when fuel prices surge to all-time highs and just when the buying power of the dollar has reached it's all-time low EnviroSpec has rolled back most pricing to where they were 5 years ago.

And - on top of that - if you should happen to find it for less elsewhere we will beat their price by another 5%.
We don't think you will but here is the offer anyway.

Also, remember that 100% of all after tax profits from your purchase go to fund Suzie's Friends Animal Shelter as well as our Spay/Neuter and adoption programs in other communities

Unheard of Quality at unheard of prices!

COOLDRIVE



**HONDA
ENGINES**

Distinguishing Features

- Patented Cooling Technology
- Cool Air Ventilation Slots
- Perm-A-Line Belt Tension System
- Laser Aligned Pulley Fanning System
- Quick-Release Belt Guard Knobs
- Flat-Free Foam Filled Tires
- Industrial Aluminum Mags
- Block Mounted Unloader

Last much, much longer with the help of Special Cooling Fins that are attached to the pulley keeping clean, cool air passing over the pump and engine.

Comes standard with **GENERAL PUMPS**

that safely shuts down the engine in the event you leave the machine in by-pass to long causing the pump head to overheat.

Premium Wheels
Tough powder coated Frame

MODEL	PSI/GPM	ENGINE/HP	PUMP	PRICE
#CD2021H	2600 - 5.6	Honda 13	General TS2021	\$1,550.53
#CD2021C	2600 - 5.6	LIFAN 13	General TS2021	\$1,350.52
#CD1511H	3500 - 4.0	Honda 13	General TS1511	\$1,425.09
#CD1511C	3500 - 4.0	LIFAN 13	General TS1511	\$1,125.18

SAVE 5% = E-Mail to soap4hope@envirospec.com o FAX to 1-888-851-7278

Do you want the absolute lowest prices in 2008?

Give us a blanket order for Chemicals along with scheduled ship dates and receive longest discounts on Chemical. In addition, you could become a Premier Customer and receive additional savings on almost everything else in the catalog.

Ask your Sales Rep for details.

LASER DECKS

Concrete, Roof, Tile, Patios, Garage Floors

Up to 4,000 PSI

STAINLESS STEEL

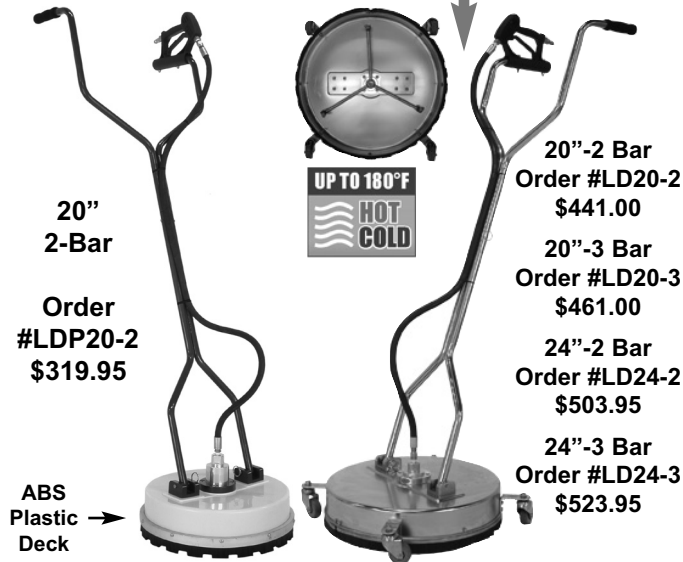

20"
2-Bar

Order
#LDP20-2
\$319.95

ABS
Plastic
Deck

20"-2 Bar
Order #LD20-2
\$441.00

20"-3 Bar
Order #LD20-3
\$461.00

24"-2 Bar
Order #LD24-2
\$503.95

24"-3 Bar
Order #LD24-3
\$523.95

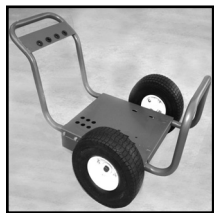

Is your cart getting tired?

BEST BUY!

Handles up to 13 HP
Powder Coated w/10" pneumatic tires
#1301 \$59.95

Looking for Burners and Repair Parts?

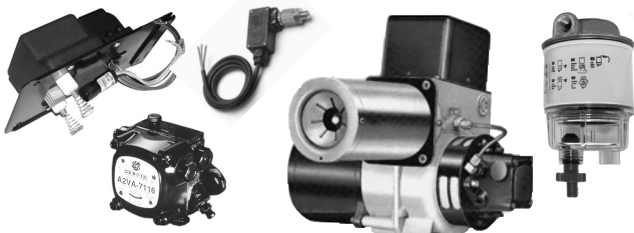

Take a look at the most comprehensive
Mobile Wash / Pressure Washer
Catalog in the industry at...

<http://www.envirospec.com>

HI-HEAT 'QUICK COUPLERS'

To hot to handle?
These couplers make it
easier to disconnect hoses
and accessories without
burning your fingers

PART #	DESCRIPTION
HQC4M	1/4" - MPT
HQC4F	1/4" - FPT
HQC8M	3/8" - MPT
HQC8F	3/8" - FPT

5%

\$3.49

12 Volt, High Volume CHEMICAL INJECTOR INDUCTION SYSTEM

The biggest complaints "EVER" with chemical injectors are:

1. With more than 125' of hose they won't draw chemical!
2. Although it is a 20% injector it doesn't draw enough chemical!
3. I wish I didn't have to use a 'pump-up' to apply bleach!

NOW YOUR HEADACHES ARE BEHIND YOU!

The Allison Chem-Inductor which includes the Allison Super Suds Sucker Injector allows you to draw an incredible amount of chemical.

The following test was based on using an injector advertised to draw at 20% (*NOT OURS*) mounted on a TS-2021 General running at 5.6 GPM.

1. With 100' of hose - Injector Only 63 oz. of chem per min.
2. With 100' of hose - WITH INDUCTOR 204 oz. of chem per min.

Now Check This Out!

3. With 500' of hose -Competitors 20% Injector 0 oz. of chem per min.
4. With 500' of hose - WITH INDUCTOR 204 oz. of chem per min.

This means that regardless of which problem you are having you will still induct almost 2 gallons of chemical per minute into the system. Never again will you have to apply the product 2 or 3 times to get the job done. Now you'll be on your way after the first pass. Roof Cleaners using bleach really love this system. No more 'pump-up' or 'back-pac' sprayers to lug around!

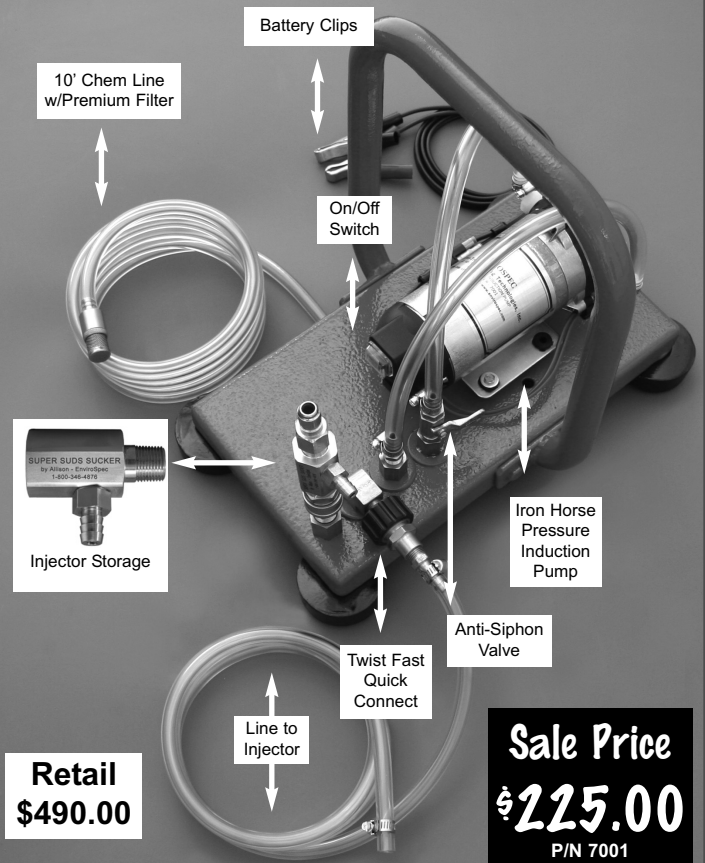

Retail
\$490.00

Sale Price
\$225.00
P/N 7001

SAVE 5% = E-Mail to soap4hope@envirospec.com o FAX to 1-888-851-7278

PRODIGY

Prodigy is, by far, one of the highest, non-caustic detergent concentrations available in the industry.

Prodigy exhibits excellent wetting, chelating, rinsing, and emulsification properties due to its high concentration of our **SuperFlo Polymer Complex System**. This exotic complex is formulated from a variety of unique dispersants, hydrotopes, and surfactants, which are not commonly found in detergent formulations.

The general rule of thumb in detergent formulation is as follows: Approximately 1 gallon of water will hold approximately 1 pound of powder before separation begins. If your product begins to separate using this method, more often than not, your product has been camouflaged with what is known in our industry as "fillers". Fillers provide little to no value to the products integrity and/or performance. They are used primarily to add weight and increase the bottom line profit for the manufacturer. Using the 1 pound per 1 gallon rule, you can see the potency of **Prodigy** when you consider that we are able to thoroughly dissolve up to 2.3 pounds of **Prodigy** into 1 gallon of water without separation. To our knowledge, no other company can make this claim. The advantage of these concentration levels are twofold: 1) the contractor is now able to clean substrates that normally require the use of caustic cleaners and 2) work faster and safer, which increases your bottom line.

As the leader in contract cleaner formulations, **EnviroSpec** goes to great lengths in providing products that are both environment friendly as well as effective, an attitude not commonly found in such a demanding industry.

Since **PRODIGY** came out in 1986 it has grown to the most asked for **Truck Wash Detergent** in the **Professional Mobile Wash Industry**.

This formula was a result of years of testing by professional mobile washers in the Northeast.

Makes Up to 110 Gallons of Concentrate

#ZPPRO \$98.95 Sale Price \$74.95 (40 Lbs)

The Original "Super Suds Sucker"- is back!

For those of you to new or young to remember...

...a few years back we designed a chemical injector that would just about suck the bottom out of the pail. Not only that - we were able to put as much as 500' of hose on the machine and still suck as much chemical as most injectors equipped with only 50' of hose.

Now for those of you who have been 'bugging' and 'begging' for the last 5 years to bring the Super Suds Sucker back you will be happy to know that it is available now.



What do most people say when they first try it?
Now this Sucks!

Part Number GPM Range
#SSS-001 3-10
supplied with additional nozzles that will handle from 2 to 10 gpm.
Complete with quick connects and Chemical Line. **READY TO GO!**

Here are the two primary advantages of owning a Super Suds Sucker and when you think about it - what else is there?:

Longevity

- This could be the last injector you will ever buy. Most of the ones we built 10 years ago are still 'sucking' strong. Yes - a rebuild kit here and there but that's about it!

Product to Surface

-When we first came out with this product we told people then that "if you can't get the product to the surface you may as well stay at home" - the same holds true today. With a Super Suds Sucker you will definitely get the product to the surface.

Regular \$99.95

\$44.95



5% Quick Connects

Brass Couplers		
PART #	DESCRIPTION	SALE
QCS4F	1/4" FPT	\$1.85
QCS4M	1/4" MPT	\$1.85
QCS8F	3/8" FPT	\$2.20
QCS8M	3/8" MPT	\$2.20
Stainless Couplers		
QCS4FS	1/4" FPT	\$3.35
QCS4MS	1/4" MPT	\$3.35
QCS8FS	3/8" FPT	\$4.10
QCS8MS	3/8" MPT	\$4.10
Plated Steel Plugs		
PART #	DESCRIPTION	SALE
QCP4F	1/4" FPT	\$.80
QCP4M	1/4" MPT	\$.80
QCP8F	3/8" FPT	\$.90
QCP8M	3/8" MPT	\$.90
Stainless Plugs		
QCP4FS	1/4" FPT	\$1.55
QCP4MS	1/4" MPT	\$1.55
QCP8FS	3/8" FPT	\$1.80
QCP8MS	3/8" MPT	\$1.80

THE MOST INCREDIBLE QUICK COUPLERS

you will ever see!

At the present time these couplers are only offered in 1/4" & 3/8" FPT.

1/4" FPT P/N QC4F
3/8" FPT P/N QC8F

\$4.45

Here you see just how easy it is to attach a 'quick connect' plug



Simply insert the plug and push!

When you want the plug to release you will pull down on the collar and the plug will automatically release itself and 'snap' out of the coupler.





LIMONENE

The Industry's
#1 SELLING
Exterior House Wash

Contains
Orange Peel Solvents
&Gloss Enhancers

With the evolution of the environment conscious homeowner more and more contractors are looking for an effective alternative to the less friendly bleach and solvents commonly found in surface chemistry dealing with wood, aluminum and vinyl siding.

These solvents, coupled with specific pH balanced surfactants and builders, provide the contractor with excellent command of the "ever changing" exterior house washing market.

Limonene has excellent hydrotoping characteristics through the use of a unique dispersant complex which is not commonly found in detergent chemistry. This complex, known as **SuperFlo Polymer**, has been developed by EnviroSpec and is found throughout our detergent formulary because of its tremendous emulsifying capabilities.

At the onset of the formulation process we took into consideration that many contractors use cold water pressure washers. Generally speaking, the use of cold water systems will result in a difficult rinsing process with most detergents. You will find that **Limonene** has superior rinsing qualities in both hot and cold water environments. The end result? You will clean faster and safer with **Limonene**.

Limonene is another step that has been taken by EnviroSpec to provide our customer with environment friendly, Top Shelf cleaning products without sacrificing aggressive surface activity required by the professional.

Makes Up to 110 Gallons of Concentrate

#ZPLIM ~~\$99.95~~ Sale Price ~~\$81.95~~ (53 Lbs.)

EMULSIFIER PLUS

Bleach Friendly DETERGENT

For the very best of all worlds
add 3 gallons of product to 2 Gallons of Bleach
Contains Gloss Enhancers

Emulsifier Plus - is one of the Original House Wash Formulas developed by EnviroSpec. Knowing that Bleach works better than anything for killing and cleaning Mildew and taking into account that Bleach does absolutely nothing about cleaning carbon type pollutants such as acid rain, exhaust carbons, dirt, grease and grime the dilemma was - how to do both at the same time!

Bleach, for the most part, does not like to be blended with other chemical products and many of the chemical products found in the professional mobile wash industry can create a serious explosive situation when mixed with sodium hypochlorite (bleach). **Emulsifier Plus**, on the other hand, is the answer to both the safety issue as well as the cleaning problem. These two products work extremely well together when blended and applied in accordance with the EnviroSpec instructions. Have the best of both worlds - Clean and Kill Mildew and Clean All the other Pollutants typically found on an exterior substrate. And do it all in one pass!

Emulsifier Plus has a pH of around 11.8 to 12.0 in a 1% solution. This unique blend of Surfactants & Builders has been specifically formulated for the House Wash Industry as a stand alone detergent or a detergent additive to be blended together with Bleach.

Emulsifier Plus works great on removing heavy build-ups of grease, grime and general fallout pollutants generally found in high traffic areas and exhibits excellent wetting, chelating, rinsing, and emulsification properties. Its ability to hold pollutants in suspension during the wash process makes it an ideal product when using either hot or cold water pressure washers.

Emulsifier Plus comes packaged in a single very moist powdered system which is loaded with specialty solvents and gloss enhancers.

Makes Up to 110 Gallons of Concentrate

#ZPEMUP ~~\$84.95~~ Sale Price ~~\$68.95~~ (40 Lbs.)

THE NOZZLE KEEPER



5%

\$8.95

- NEVER lose another nozzle!
- Install your favorite nozzles
- For 3 nozzle set-ups
- Nozzles sold separately

Another EnviroSpec
Exclusive!

PART #
KB003

Best Price in the Country!

18 HP Vanguard

Hot Water Ready with 20 Amp Recharging System
If you are replacing a Briggs on a hot water machine with a
12 volt burner this is the

Only Briggs Engine that will work!



Sale Price
\$995.00

#BS18

Call your orders in or 'Shop On-line' to save an additional 5% on most items.

America's Favorite Pressure Washers are now equipped with **HI-TEMP GENERAL PUMPS**



This 'ready to go system' is equipped as follows:

- o 13 HP Engine with easy start and low oil shut-down
- o General Pump with hi-heat system
- o Unloader
- o Safety relief Valve
- o Chemical Injection
- o Gun, Hose & Lance
- o 5 Quick Connect Nozzles
- o 'Tuff-Coat' Frames

These Hi-Temp General Pumps are designed to Shut-down a gas engine in the event the pump head overheats. This is a common occurrence when the trigger is released and the pump goes into by-pass. Typically the pump head will begin to overheat within 3 minutes from the time the trigger gun is released. This will spike the pump head to approximately 150°. Here is where you start losing packing life. Within 4-5 minutes without introducing fresh water into the system you have lost approximately 10-20% of your packing life expectancy. At \$ \$150 to \$400.00 a pump head rebuild you can see where these units will pay for themselves in a short period of time.

MODEL	PSI/GPM	ENGINE/HP	PUMP	PRICE
#2021H	2600 - 5.6	Honda 13	General TS2021	\$1,514.38
#2021C	2600 - 5.6	LIFAN 13	General TS2021	\$1,192.47
#1511H	3500 - 4.0	Honda 13	General TS1511	\$1,386.94
#1511C	3500 - 4.0	LIFAN 13	General TS1511	\$1,085.03

ALLISON "SUDS SUCKER"

READY TO GO 'SUDS SUCKER'

THE BEST

"DRAW RATES"

IN THE INDUSTRY

DESIGNED BY:

ENVIROSPEC



ADJUSTABLE

#5010C
2-5 GPM

#5011C
5-8 GPM

\$16.95

NON-ADJUSTABLE

#5004C
2-5 GPM

#5005C
5-8 GPM

\$13.95

Complete with:

STAINLESS QUICK CONNECTS
10' OF CHEMICAL LINE

OUR BEST STAINLESS & BRASS CHEMICAL FILTER

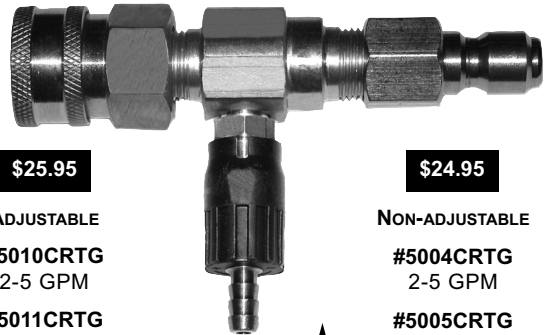

\$25.95

ADJUSTABLE

#5010CRTG
2-5 GPM

#5011CRTG
5-8 GPM

\$24.95

NON-ADJUSTABLE

#5004CRTG
2-5 GPM

#5005CRTG
5-8 GPM

More EnviroSpec
Exclusives!

- Up to 20% DRAW RATE
- Machined Brass
- Ceramic Ball for harsh chemicals & chlorine
- 316 Stainless Nozzle
- Rated to 5,000 PSI
- Viton® O'ring

5%

These unique features guarantee you Allison Injectors are the best in the industry!

OUR #1 SELLING
Cold Water
Pressure Washer

REGULAR PRICE \$1,295.00
#UBI-4035



\$599.00
4.0 GPM
3500 PSI

3,500 PSI
4.0 GPM
13 HP
Lo-Oil Shutdown
General Pump
2 Wheel Cart

Chem Injector
Unloader
Safety Valves
Does not include:
Hose, Gun, Nozzles
Minor Assembly
Required

**Add \$50.00 for Hi-Temp
General Pump Shut-down**

#1 HIGH VOLUME
Cold Water
Pressure Washer

REGULAR PRICE \$1,795.00
#UBI-5526

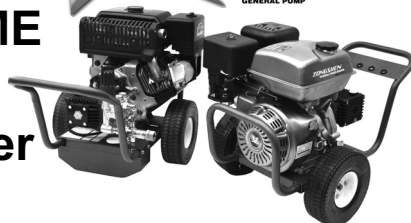

\$799.00
5.5 GPM
2600 PSI

2,600 PSI
5.5 GPM
13 HP
Lo-Oil Shutdown
A-R Pump
2 Wheel Cart

Chem Injector
Unloader
Safety Valves
Does not include:
Hose, Gun, Nozzles
Minor Assembly
Required

GENERAL PUMP TS-2021

5.6 GPM
3,500 PSI
1450 RPM
AS LOW AS
\$399.95

Sale Priced at...
\$421.00
less your 5%
e-Mail/Fax Order
= \$399.95

Industry's #1 Selling Pump



5%

CAUTION: There are two companies that we know of that are selling a TS-2021B that is not a genuine TS-2021 and does not carry the General Pump Warranty.

Serpentine - the Industry's Best & Longest Lasting High Pressure Hose



5%

Black, 3,000 PSI, 50'	P/N B308-050	\$39.50
Black, 3,000 PSI, 100'	P/N B308-100	\$75.50
Grey, 3,000 PSI, 50'	P/N G308-050	\$42.95
Grey, 3,000 PSI, 100'	P/N G308-100	\$82.95
Black, 4,000 PSI, 50'	P/N B408-050	\$41.25
Black, 4,000 PSI, 100'	P/N B408-100	\$84.95
Grey, 4,000 PSI, 50'	P/N G408-050	\$44.50
Grey, 4,000 PSI, 100'	P/N G408-100	\$84.50
Black, 4,500 PSI, 50'	P/N B458-050	\$55.83
Black, 4,500 PSI, 100'	P/N B458-100	\$99.95
Grey, 4,500 PSI, 50'	P/N G458-050	\$65.35
Grey, 4,500 PSI, 100'	P/N G458-100	\$119.95



5%

Up to 4500 PSI

Holds 50'	P/N 30001	\$39.95
Holds 100'	P/N 30002	\$54.95
Holds 150'	P/N 30004	\$69.95
Holds 200'	P/N 30006	\$74.95

Super Swivel

HOSE REEL SWIVEL
5,000 PSI
Grease Fitting for extended service life

5%



5455-101
3/8 In / 1/2 Out

\$29.95

"Best Buy" Ball Valve

5%



6,000 PSI
316 STAINLESS

Part #	DESCRIPTION	
89551	1/4F x 1/4F	\$26.95
89552	3/8F x 3/8F	\$39.95
89553	1/2F x 1/2F	\$44.95

3/8" - 7500 PSI
BALL VALVE

Reg Price \$74.95

Sale Price
\$17.95

P/N 2923-104

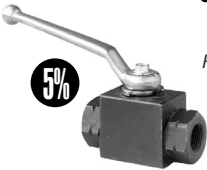

THROTTLE CABLE - FITS ALL ENGINES



5%

- For precise engine speed control
- Auto Pre-sets
- Push Pull or 'Snap' Pull and lock
- Designed for harsh, moist environments

\$34.95

PART #
4616-850

NEW

4-Section Telescoping Wand

\$89.95

#TW244-4

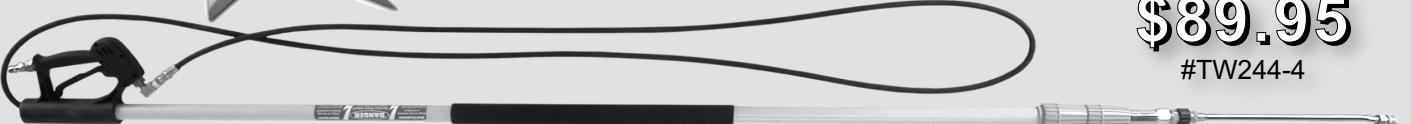

Become a PREMIER CUSTOMER today and Save even more!

SHURFLO PUMPS

with Chemical Resistant
Seals & Valves

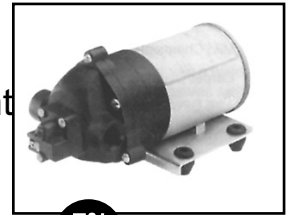

5%

12 VOLT SHURFLO PUMPS with PREMIUM VALVES

PART #	DESCRIPTION	
1231-101	1.4 GPM / 60 PSI / Viton Valves	\$ 69.95
1231-102	1.8 GPM / 100 PSI / Viton Valves	\$ 77.95
1231-103	3.0 GPM / 45 PSI / Viton Valve	\$ 79.95
1231-104	3.6 GPM / 45 PSI / Viton Valve	\$129.95

115 VOLT SHURFLO PUMPS with PREMIUM VALVES

PART #	DESCRIPTION	
1231-201	1.4 GPM / 60 PSI / Viton Valves	\$ 94.95
1231-203	1.5 GPM / 150 PSI / Viton Valves	\$149.95
1231-301	1.6 GPM / 100 PSI / Viton Valves	\$124.95

12" ROOF & TILE CLEANER

Rated to 4,000 PSI this 'tuf' guy' will get the job done in a flash!



- Roofs
- Tile Floors
- Cedar Shakes
- Decks

This cleaner will get in places that larger cleaners can't.

Great Tool...
at a Great Buy!

#LDP12-2	Deck	\$89.95
#85400066	Gun Kit	\$22.95



EnviroSpec

751 MLK Highway
Homerville, GA 31634

Looking for
Hot Water Equipment?

How about

\$4095.00

for all this!

3,500 PSI - 5.6 GPM

TS-2021 Pump

18 HP vanguard

The most popular design
in the industry.

*Built for durability
& easy access!*

also available with **HONDA**
20 Horsepower **ENGINES**



ADD \$600.00
for 20 HP

HONDA
ENGINE

Add \$600.00
for 120 Volt AC
Generator Version

- 3,500 PSI
- 5.6 GPM
- 18 HP Vanguard
- 20 Amp Recharging
- Electric Start
- TS2021 Pump
- Belt Drive System
- Gun, Hose, Nozzles
- 12 Volt Burner
- Large Fuel Tanks
- Fuel Filter
- Rugged Frame
- Hi-Heat Coil



Cash In Advance - Certified
on all Hot Water Equipment

Looking for High
Volume

Hot Water Equipment?

How about

\$5795.00

for all this!

3,600 PSI - 8.6 GPM

TSF General Pump

30 HP KOHLER



Add \$600.00
for 120 Volt AC
Generator Version

- 3,600 PSI
- 8.6 GPM
- 30 HP KOHLER
- 25 AMP Recharging
- Electric Start
- TSF Pump
- Belt Drive System
- Gun, Hose, Nozzles
- 12 Volt Burner
- Large Fuel Tanks
- Fuel Filter
- Rugged Frame
- Hi-Heat Coil



also available
up to 10 GPM

**We accept VISA, Master Card
Discover & AMEX**

**Hot water equipment must be paid for in
advance by Certified Funds**

Minimum Order is \$50.00

As the industry's most trusted supplier
EnviroSpec sells only first line - brand new
products. We do not refurbish used
products and sell them as new. We have a
total of 35,000 square feet of industrial
space in two States and we will not show
you pictures of our suppliers/manufacturers
facilities to mislead you in to thinking theirs
are ours.

...and remember - when you see the



you will save and additional 5% off on that
item if you e-Mail or Fax your order to us.

Shipping from: Milwaukee, WI or Homerville, GA - 1-800-346-4876

Minimum Order \$50.00 - Revised Date: 4-15-08

CATALOG 05070915